

# EMERGING WIRELESS TECHNOLOGY™

A Prism Business Media Publication

A SUPPLEMENT TO RF DESIGN MAGAZINE

[www.rfdesign.com](http://www.rfdesign.com)

November 2006

## UWB 360

Office



Travel



Car



Home



Shopping



# MODERN • ART

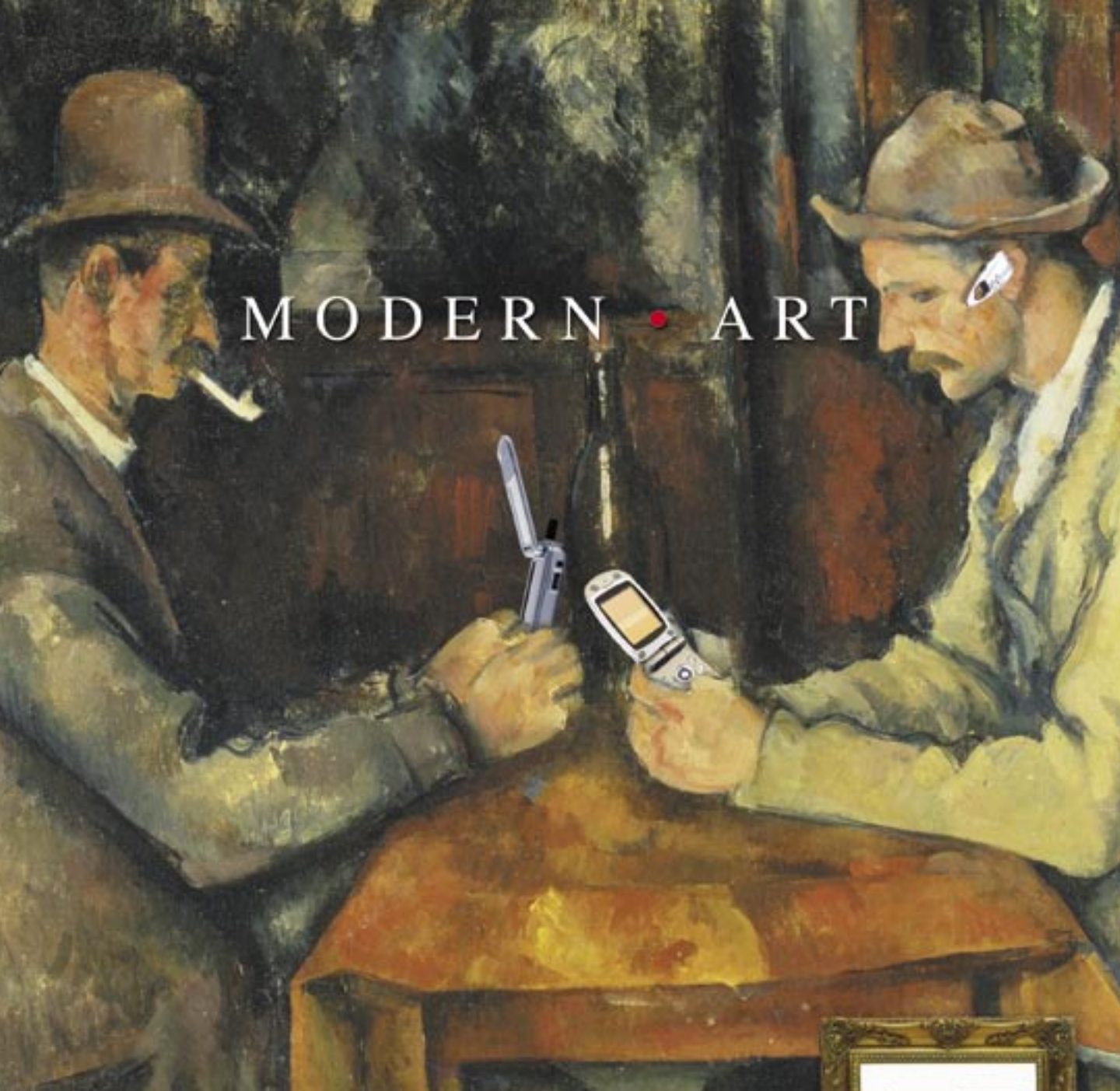

With RFMD's *Bluetooth*® solutions, taking care of business takes on a whole new meaning. The RF4020 system-on-chip consumes up to three times less power without compromising RF sensitivity—its small size makes it easy to integrate and it implements all features of the *Bluetooth* V2.0 + EDR specification with support for the upcoming Version 2.1 (Lisbon) specification. The SiW1722 transceiver, designed for CDMA handsets, minimizes current draw while increasing effective battery life—and offers lower system costs with fewer external components. Thanks to RFMD®, the next generation in *Bluetooth* chip technology is bringing to the table a whole new way to connect and exchange information.

#### RF4020 System-on-Chip

- 4.5 x 4.5mm and Wafer Level Chip Scale packages
- 5µA shut-off current extends standby time
- 9mA average current in HV3 audio delivers longer talk time
- Exceeds *Bluetooth* specification for receiver sensitivity by as much as 15dB

#### SiW1722 Transceiver

- Designed for use with MSM chipsets with integrated *Bluetooth* baseband
- On-chip 50-ohm RF match network with no external impedance matching components
- Supports multiple external reference clocks or crystal frequencies with on-chip reference Phase Lock Loop (PLL)
- On-chip voltage regulation simplifies voltage input requirement and system design



**RFMD** 

[rfmd.com](http://rfmd.com)

[ Invention is the art of science. ]

Frequency  
Solutions

# 2.5x2.0mm Crystals For Ultra-Wideband & Bluetooth Applications

Make the most of your Ultra-Wideband (UWB) & Bluetooth devices by utilizing NDK's 50 plus years of frequency control experience. Try the 2.5x2.0mm industry standard NX2520SA crystal in your next oscillation circuit. We have developed standard frequencies for UWB including; 24, 40, 44, & 48MHz and for Bluetooth 16, 26, & 32MHz.

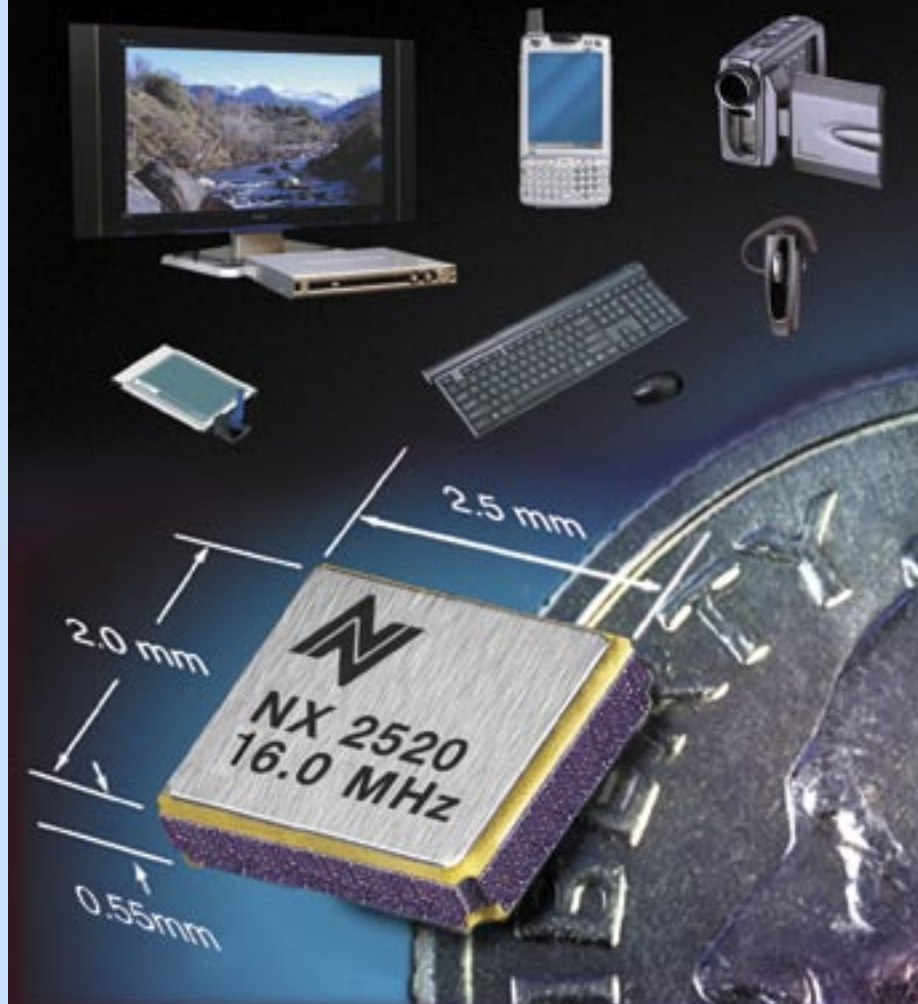

## Specifications:

Attribute	Value
Frequency Range	16~48MHz
Frequency Tolerance at 25°C	±10ppm
Frequency Stability vs. Temp	±15ppm over -10 to +60°C
Std. Load Capacitance	8/9/10pF



RoHS Compliant

Contact NDK For Solutions To Your Frequency Requirements



Crystal Bridge to the Future

800-NDK-XTAL (635-9825)  
email: [sales@ndkxtal.com](mailto:sales@ndkxtal.com)

[www.ndk.com](http://www.ndk.com) • Fax: 815-544-7901

# features

**State of the UWB industry** . . . . . 8  
*While the IEEE failed to reach consensus on UWB, efforts of the WiMedia Alliance and others has created a huge wave of momentum to ensure its worldwide adoption.*  
 — By **Jeff Ravencraft and Stephen R. Wood**

**A closer look at UWB market adoption** . . . . . 12  
*The success of UWB will depend in part on the combination of different wireless technologies with UWB-enabled equipment based on different PALs.*  
 — By **Fiona Thomson**

**Technology design options for WiMedia devices** . . . . . 14  
*While UWB presents a golden opportunity for many, a company's approach to implementation can play a critical role in defining its success.*  
 — By **Billy Brackenridge**

**Understanding WiMedia Association models and security** . . . . . 16  
*Learning from mistakes of the past, the WiMedia Alliance has forged a secure future for UWB.*  
 — By **Preston Hunt**

**Understanding ATE production test** . . . . . 18  
*With careful test strategy consideration, semiconductor companies can achieve product quality and cost aspirations for the UWB market.*  
 — By **Kyle Klatka**

**A look at the worldwide regulatory process** . . . . . 19  
*While it remains to be seen if a common harmonized spectrum for multidevice interoperability will prevail, most major geographies will have some spectrum opened up in 2007.*  
 — By **Roberto Aiello and Jeff Foerster**

**Ensuring Wireless USB quality assurance** . . . . . 20  
*These five steps can help manufacturers ensure a positive experience for users of products based on Wireless USB.*  
 — By **Mario Pasquali**

**Timely WiMedia solutions fuel UWB Ecosystem expansion** . . . . . 22  
*Earlier wireless support lessons prove valuable, but the timing of resources is more critical than ever.*  
 — By **Mike Tanahashi**

**Testing WiMedia-based receivers and transmitters** . . . . . 25  
*Testing throughout the implementation stages provides a predictable path to conformance to the WiMedia specification.*  
 — By **Mark Lombardi**

**A closer look at UWB regulatory testing** . . . . . 26  
*There are many challenges to testing UWB equipment, having a clear understanding of the regulations, therefore, is crucial.*  
 — By **Pat Carson**

**Standards compliance simplified** . . . . . 28  
*Compliance and certification programs are key to the proliferation of UWB technology.*  
 — By **Brad Hosler**

**Software considerations around Wireless USB** . . . . . 29  
*Along with hardware, software is a major enabler of Wireless USB's overall success.*  
 — By **Fred Bhesania**

## departments

<b>Editorial</b> . . . . . 6	<b>WiMAX Product Highlights</b> . . . . . 33
<b>WiMAX Tips</b> . . . . . 30	<b>Ad Index</b> . . . . . 34
<b>News Headlines</b> . . . . . 31	<b>Editorial/Sales Staff</b> . . . . . 34
<b>Guest Editorial</b> . . . . . 32	

S  
T  
R  
E  
T  
T  
O

# The race is on.



©2006 Staccato Communications

## UWB University



With free live and on-demand online webinars and an interactive message board, UWB University provides a comprehensive forum for engineers and business people.

For free enrollment and more information, visit: [www.uwb-u.com](http://www.uwb-u.com)

## Certified Wireless USB - 480Mbps Single-Chip, All-CMOS Complete Solutions

Staccato Communications accelerates your time to market with Certified Wireless USB. Silicon, Development Kits, Reference Designs, XP Drivers, Complete Solutions.



URL: [www.staccatocommunications.com](http://www.staccatocommunications.com)  
Contact: [sales@staccatocommunications.com](mailto:sales@staccatocommunications.com)



*Cheryl J. Ajluni*

By Cheryl Ajluni, Editor

## UWB's inflection point is at hand!

With manufacturer's now working feverously on ultrawideband (UWB)-based consumer products and the radio chips that drive them, and the WiMedia Alliance ([www.wimedia.org](http://www.wimedia.org)) and USB Implementer's Forum ([www.usb-if.org](http://www.usb-if.org)) working on worldwide regulatory adoption and certifying products, it seems abundantly clear that the UWB industry is on the cusp of an inflection point. It has come to a critical point in its existence and is now facing a major turning point. Andy Grove, the founder of Intel, once defined inflection point as "an event that changes the way we think and act." For some, the commercialization of the first UWB protocol—Certified Wireless USB from the USB Implementer's Forum—may be just such an event.

Certified Wireless USB products are expected to start hitting the streets by the end of 2006 and will include things like dongles and add-in cards for upgrading legacy PCs. The roll out of Certified Wireless USB will then continue as it is integrated into virtually any application that today supports wired USB. In the process, it is expected to redefine mobility as we now know it. Or, as Andy Grove so astutely pointed out, it will change the way we think and act with regard to mobility. The new mobile experience will offer consumers wired USB functionality anytime, anywhere, but it will do so wirelessly. Consumers will also have access to a whole new range of multimedia applications and services, enabled by the high-speed data transmission capabilities of UWB.

Of course, Certified Wireless USB is not the only UWB protocol expected to leave a lasting mark on the industry. Earlier this year, the Bluetooth Special Interest Group ([www.bluetooth.org](http://www.bluetooth.org)) decided to work with the WiMedia Alliance to define the high-speed Bluetooth technology specification dubbed Bluetooth 3.0. This protocol, similar to Certified Wireless USB, runs atop the WiMedia Common Radio Platform, making it possible for silicon providers to offer simultaneous operation of both protocols on the same chip.

UWB will one day soon be implemented in battery-operated, handheld applications requiring miniaturized module solutions. The cellular phone is a prime example of just such an application. In fact, according to the market research firm IMS Research ([www.imsresearch.com](http://www.imsresearch.com)), roughly 120 million mobile phones will be equipped with UWB in the year 2010 alone. This makes perfect sense considering that Bluetooth and USB are so widely received, having recently reached an installed based of one billion products and of two and a half billion respectively. Certified Wireless USB and Bluetooth 3.0 offer different capabilities at the protocol layer, and integrating good implementations of the WiMedia UWB platform into consumer products will enable both protocols.

With such a range of activity and excitement being generated around UWB, it seems certain the inflection point for this industry is at hand. This issue of emerging wireless technology, written and pulled together with help from the WiMedia Alliance, the USB Implementer's Forum and many others heavily involved in UWB, is for anyone who intends to be an active participant in this growing industry. It is packed with information on every aspect of the UWB industry—business cases, market projections, hardware, software, testing, regulatory, certifications, etc...

We hope it serves you well as a trusted resource and guide in the months and years ahead. **EW**

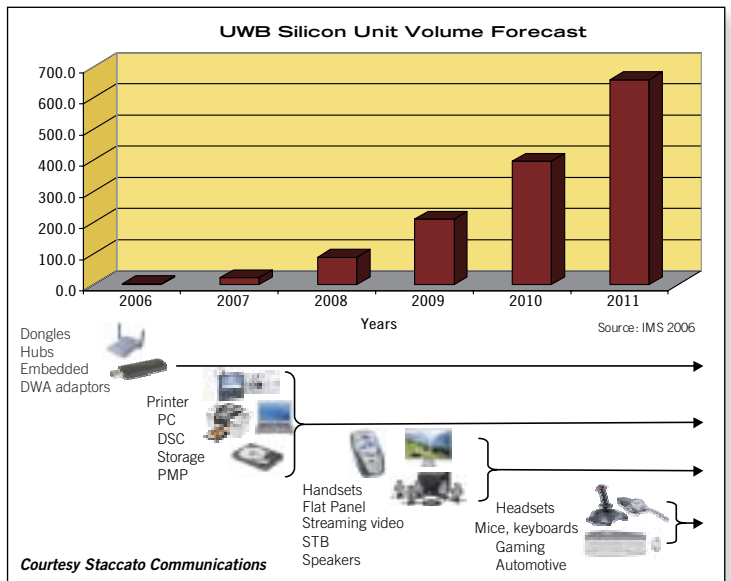

1,000,000,000

# SUCCESS IS SEEING YOUR VISION WITH NINE ZEROS BEHIND IT.

Congratulations to our 6,000+ member companies who've taken *Bluetooth* wireless technology from one vision to a one-billion-product reality.

Join us as we work toward the next billion.



Experience more at [www.bluetooth.com](http://www.bluetooth.com)

Bluetooth SIG Promoter Members:

agere systems

ERICSSON



lenovo

Microsoft



NOKIA

TOSHIBA

# State of the UWB industry

While the IEEE failed to reach consensus on UWB, efforts of the WiMedia Alliance and others has created a huge wave of momentum to ensure its worldwide adoption.

By Jeff Ravencraft and Stephen R. Wood

The closing of 2006 has initiated an increase in the momentum behind ultrawideband (UWB) technology as the industry prepares to launch end-user applications, by way of Certified Wireless USB. While manufacturers are putting the final polish on consumer products and the radio chips that drive them, organizations like the WiMedia Alliance and the USB Implementers Forum (USB-IF) are working on regulatory adoption in preparation for a worldwide market. As this awaited launch draws near, it is important to remember how UWB technology emerged and the vision for the future.

## Standards

After a three-year debate within IEEE failed to reach consensus over two UWB modulation techniques, the participants supporting multiband orthogonal frequency division multiplexing (OFDM) and direct-sequence UWB voluntarily ceased IEEE-sanctioned work on UWB standardization. The committee was officially dissolved in January 2006. This occurrence marked the escalation of UWB efforts within two competing organizations: the WiMedia Alliance and the UWB Forum. With the objective of creating a true global standard, the WiMedia Alliance began working with Ecma International before parting from IEEE. Because the Ecma proceedings

were handled under different procedural rules, the WiMedia Alliance was able to generate an approved standard (Ecma 368 and 369) by December 2005.

Ecma 368, which describes the physical (PHY) and media access control (MAC) layers, was subsequently delivered to and approved by the European Telecommunications Standards Institute (ETSI) for use

After a three-year debate within IEEE failed to reach consensus over two UWB modulation techniques, the participants supporting multiband orthogonal frequency-division multiplexing (OFDM) and direct-sequence UWB voluntarily ceased IEEE-sanctioned work on UWB standardization.

within Europe. The Ecma international standards were also combined and submitted into the ISO approval process. They were voted on and are expected to be finalized before the end of 2006. The intent of ISO approval is to establish international recognition for the standard.

This round of standardization is built on the current United States regulations, which provide authorization to use 3.1 GHz to 10.6 GHz of spectrum. As other countries finish their regulatory processes, the standards will be updated to reflect those conditions.

## Regulations

Obtaining regulatory approval worldwide is vital to the success of UWB and the products that are dependent on this radio platform. This process was initially started in 1998 and is now coming to fruition. The Federal Communications Commission (FCC) was first to issue rules to allow UWB in early 2002. Once these rules were established, a great deal of work was done to exhaustively evaluate UWB in the International Telecommunications Union (ITU), Europe and Asia. The work within ITU provided a body of data and recommendations that are now being reviewed by countries around the world. Following the conclusion of the ITU evaluation, Japan issued UWB rules in August 2006. Canada, Europe and South Korea

appear to be following suit with acceptance expected between now and mid-2007. By that time, a worldwide UWB footprint should to be established in all major geographies. China is also evaluating UWB and anticipates having regulations in place by the end of 2007.

These regulatory decisions will provide enough spectrum to enable the launch of the UWB industry. This progress, however, does not indicate the conclusion of UWB efforts. Because this is the first time regulators have used the underlay tech-



If you think all  
wireless connections  
are the same, don't worry.  
There are places  
you can go for help.



Mental note: Certified Wireless USB is the inevitable wireless platform of the future. Like its wired predecessors, it connects up to 127 devices simultaneously. And moves huge amounts of data with speed (up to 480 Mbps),

security and simplicity. Brought to you by the minds behind original and Hi-Speed USB, this technology has been optimized for wireless connectivity. For more mind-bending facts, go to [www.usb.org/developers/wusb](http://www.usb.org/developers/wusb).



FIRST PRODUCTS COMING SOON

Information brought to you by the USB Implementers Forum

nique, where spectrum is allocated by overlapping a broad group of allocations, countries are being cautious with regulatory requirements. As more data about UWB's operational characteristics is gathered from industry practice, further refinement of the allocations is probable.

## Special interest groups

As a technology, UWB enables applications in the consumer electronics, personal computer and mobile handset markets. The USB-IF is the principal organization managing products in the PC peripheral and CE environments. In the mobile handset market, the Bluetooth SIG is currently the principal organization.

In practice, the PC, CE and mobile handset applications operate near a personal computer and around a television. If each active industry group were to generate a separate UWB radio design to address these needs,

there is a high probability that an unacceptable level of interference would occur. At the very least, the devices would not communicate and market fragmentation, coupled with customer confusion, would result. To combat these potential problems, the WiMedia Alliance structured an approach whereby it created a common radio platform that is shared with multiple protocols such as Certified Wireless USB, Bluetooth and WiMedia's IP stack. Through this approach, it is possible for devices to coordinate their activity, avoid interference and maximize economies of scale.

## Launch expectations

UWB is rapidly approaching market launch. Engineers are presently completing final work on interoperability testing and certification. It is expected that this work will be finished and products will start to arrive in customer hands during the last quarter of 2006 and first quarter of 2007. Initially, there will be chips provided from approximately six manufacturers, with this number growing rapidly over the course of the first 12 months. Approximately 12 to 15 manufacturers are believed to be preparing UWB chips for market.

Certified Wireless USB from the USB-IF will be the first UWB protocol to be in products by the end of 2006. Initial products will include host wire adapters (HWA) in the form of dongles or add-in-cards, which will upgrade legacy PCs. Device wire adapters (DWA) will also be available in the form of Wireless USB hubs to upgrade legacy peripherals. First products will introduce the Certified Wireless USB technology and allow users to bring the technology to their legacy equipment. As the marketplace transitions, expect to see the integration of Certified Wireless USB technology into such things as cameras, external hard drives, PCs, printers, and MP3 players—the same applications that support wired USB today.

Certified Wireless USB is the future of mobility. Soon, consumers

will experience a wireless personal area network (WPAN) where hosts and devices interoperate seamlessly, easily and securely without clutter, regardless of their location. It will preserve the functionality of wired USB while also unwiring the cable connection and providing enhanced support for streaming media CE devices and peripherals. Built from the ground up and optimized for a wireless medium, Certified Wireless USB supports high data-rate wireless connectivity and delivers the same speed (480 Mbps at three meters and 110 Mbps at 10 meters) and ease-of-use experienced with wired USB today. It is powered by the WiMedia UWB Common Radio Platform as developed by the WiMedia Alliance. UWB technology delivers a solution for high bandwidth, low-cost, low-power consumption, and physical size requirements of next-generation consumer electronic devices.

Built to perform, Certified Wireless USB is optimized for power management, operating system (OS) support, and data throughput and bandwidth allocation for isochronous support. To ensure performance, the USB-IF will provide testing capabilities for Certified Wireless USB compliance and certification. Member companies can test products for interoperability and compliance to the specification through the Certified Wireless USB compliance and certification program. This program will ensure high-quality, interoperable products enter the marketplace. Member companies whose products receive certification and have signed a logo license agreement with the USB-IF, are permitted to use the Certified Wireless USB logo on all certified products. The USB-IF will promote logo adoption through the Certified Wireless USB logo awareness program, which communicates the brand promise to OEMs/ODMs, the channel and the general consumer. **EWT**

## ABOUT THE AUTHOR



*Jeff Ravencraft is the president and chairman of the USB Implementers Forum. Stephen R. Wood is the president of the WiMedia Alliance.*

**KC Wirefree**  
*We Make Wireless Work For You!*  
[www.kcwirefree.com](http://www.kcwirefree.com)





Licensed Wireless Modules  
Ready to Install

Embedded  
Serial Port Profile

 Bluetooth  RoHS

## OEM WIRELESS DATA SUBSYSTEMS

- Fully Embedded Bluetooth
- UART and SPI Connections
- Fast Serial up to 921 Kbit/s
- High Security 128 bit Encryption
- Range 20 to 100 Meters
- 2.4 Ghz Frequency
- ARM7 Microprocessor
- Flash Memory 8 Mbit
- 14 General I/O Pins
- Onboard Antenna
- Customized Firmware

Evaluation Kit  
~~-\$210~~ \$160  
*mention this ad*

KC Wirefree  
Corporate 2640 W Medtronic Way  
Office Tempe, AZ 85281  
(602) 386-2640

KC Wirefree  
Engineering 1722 Ringwood Ave  
Office San Jose, CA 95131  
(408) 850-2828

# Build your wireless USB peripheral... ...without losing your wired USB port



## Certified Wireless USB

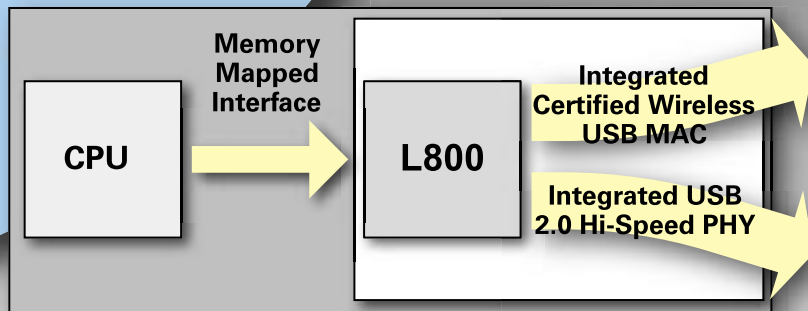

*The L800 USB Device Controller controls both wired and wireless USB connections using the same firmware.*

- 8/16 bit memory mapped interface with DMA slave support
- Up to 31 device endpoints
- Configurable buffer sizes support all burst lengths
- Integrated device association logic (cable and numeric)
- Supports most USB class drivers including mass storage, printer, scanner, and video classes
- Automatically switch between wired and wireless connections



# LucidPORT

# A closer look at UWB market adoption

The success of UWB will depend in part on the combination of different wireless technologies with UWB-enabled equipment based on different PALs.

By Fiona Thomson

**A**s an increasingly mobile lifestyle takes hold of society, mobile and wireless connectivity is fast becoming a necessity rather than a luxury. Wireless access in devices like cellular handsets and notebooks has created even greater demand for this capability in other consumer devices such as digital cameras, portable digital media players and high-definition televisions (HDTVs). Ultrawideband (UWB) technology now offers a solution for those companies striving toward the notion of “seamless mobility” as a means of enabling consumers to access their media wherever and whenever.

UWB is a high data rate (480 Mbps), short-range (typically up to 10 meters) technology designed to enable the high-speed transfer of multimedia content between various devices (e.g., in consumer electronics, personal computing and mobile device markets) in future data-intensive applications. Increased memory size in portable devices, larger file sizes for digital pictures and videos, and higher-resolution pictures and video for consumer multimedia applications have all increased the requirement for higher wireless data rates. At the same time, the drive to reduce device size, increase data rates and increase battery life means that low-power operation is a crucial design factor.

## Assessing the UWB market

Accurately assessing the future size of the UWB market depends on a number of issues, such as when products will be launched, the interaction between different application sectors and the combination of different wireless technologies and

Increased memory size in portable devices, larger file sizes for digital pictures and videos, and higher-resolution pictures and video for consumer multimedia applications have all increased the requirement for higher wireless data rates.

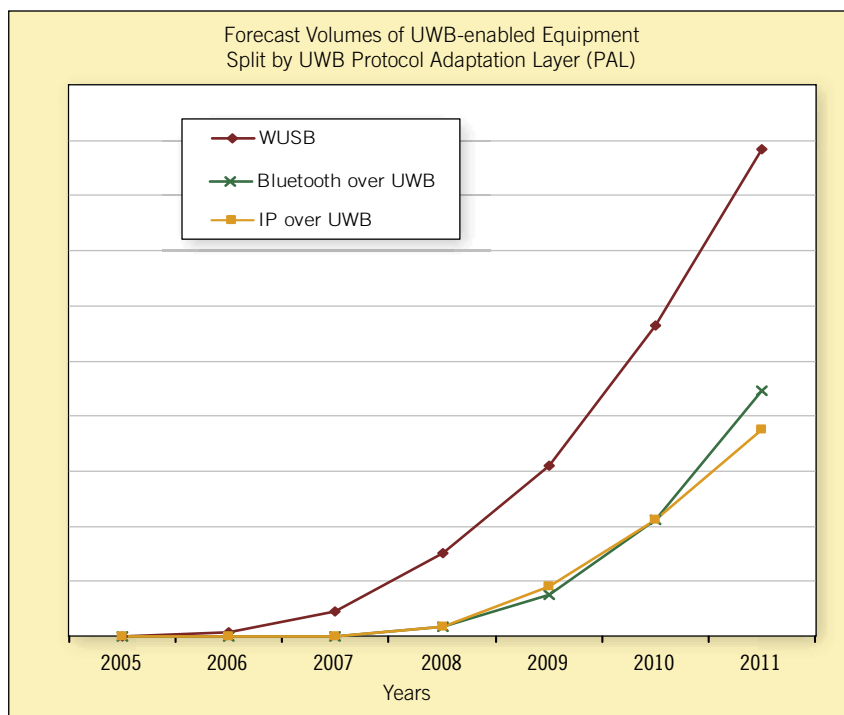

Forecast volumes of UWB-enabled equipment based on different PALs.

different UWB protocol adaptation layers (PALs) into the same products (see the figure). The popularity of different PALs and how they interact with each other in different applications has proven to be of great interest to original equipment manufacturers (OEMs). Each UWB PAL (e.g., Certified Wireless USB (WUSB), Bluetooth and WiNET (Internet protocol (IP)) is optimized for different scenarios and each will work in coexistence with technologies such as Bluetooth and WLAN.

WUSB is a wireless extension to USB, designed to preserve the functionality of wired USB without the cable. It, therefore, has the same usage scenarios as wired USB; with the PC industry providing the initial market opportunity. Because this UWB solution can be used in applications like desktop PCs, notebooks and PC peripherals, it has the potential to gain significant volume in the PC environment.

High-speed Bluetooth (which combines Bluetooth technology with UWB) is now being developed as the next evolution of the Bluetooth experience. The equipment where Bluetooth has established itself is increasingly being used to support data-hungry applications. Where once a short-range wireless connection was used to synchronize an address book, it may now be used, for example, to synchronize part of a music collection. This combination of Bluetooth with the high data rates offered by UWB, means that Bluetooth has the potential to become much more than just a voice application.

High-speed Bluetooth is being optimized for scenarios that differ from previous Bluetooth solutions. As such, it is expected to penetrate into a growing number of portable electronic devices to provide new use cases such as transferring music to a portable digital media player, downloading a music video onto a cellular handset and streaming video.

With the widespread adoption of Internet protocol-based technologies (WiNET), it is practical to run voice, video and data over a single physical data infrastructure rather than over separate networks. UWB technology can enable IP-based connectivity for the next generation of IP-based PC and consumer electronic devices. IP's peer-to-peer topology makes devices such as printers, displays and storage more accessible.

While the details provided above summarize some of the applications for which UWB is optimized, a market that cannot be ignored is the cellular handset. Consider, for example, that the sharp rise in the number of feature phones and smart phones has made the need for extra connectivity absolutely critical. Given that fact, the cellular handset is likely to be an important market for UWB for a number of reasons. The sheer size of the available market means that even

if relatively low penetration rates are achieved, there is still a huge potential market for UWB. The possible negative effect of cellular handsets on markets such as PDAs, MP3 players and digital cameras only heightens

the importance of the cellular market to the future of UWB. In addition, the cellular handset remains at the center of the wireless personal area network (WPAN). UWB's usage and presence in the cellular space, therefore, increases the likelihood that it will be successful in a number of other devices.

## Conclusion

Most of the initial 'leg work' in developing UWB and its various technology solutions appears to have been done. The future of UWB now comes down to market adoption. While worldwide regulatory approval has yet to be finalized, it is clear that momentum behind this technology is at its highest—especially now that products are being readied for market rollout. **EWT**

## ABOUT THE AUTHOR

*Fiona Thomson is a market research analyst at IMS Research.*

**PUZZLED?**  
LINX MAKES WIRELESS SIMPLE AND INEXPENSIVE

**RF Transmitter**  
**RF Receiver**

**Antennas**  
**OEM**

**Encoders & Decoders**  
**Connectors**

Visit [www.LinxTechnologies.com](http://www.LinxTechnologies.com) for all of our products.

**LINX TECHNOLOGIES** **800-736-6677**  
575 S.E. Ashley Place  
Grants Pass, OR 97526

# Technology design options for WiMedia devices

While UWB presents a golden opportunity for many, a company's approach to implementation can play a critical role in defining its success.

By Billy Brackenridge

Ultrawideband (UWB) is not a technology. It is a set of government-issued regulations that allow well-regulated access to a wide swath of RF spectrum. The WiMedia Alliance specifies an interoperable technology for exploiting this spectrum within the regulatory rules, but how WiMedia devices are built has been left to individual implementers. Decisions as to which technologies to deploy vary from company to company. Technical decisions on how to build a WiMedia-compliant device are dictated by the market, or more precisely, how different companies perceive the market.

The first proposed application for UWB was for moving video between a set-top box and a TV screen. UWB was proposed as a physical layer for IEEE 802.15.3 as this standard was well into development before regulators opened up the UWB spectrum. IEEE 802.15.3 was aimed at building wireless connections for the set-top box to TV screen. Manufacturers of battery-powered portable devices also became interested in UWB, and by the time the WiMedia Alliance was formed, the MAC layer evolved to support portable 'peer to peer' connections, as well as the set-top box application. While the WiMedia radio has its roots in IEEE 802.15.3, it evolved to take on a wider set of applications.

This split has led to a range of implementations of the WiMedia

standard. One vendor might use multiple antennas and a SiGe front-end to give a settop box a longer range and higher bit rate. Another vendor might build a single-chip CMOS implementation in a small package that can fit in a mobile phone. The set-top box and mobile phone may have little in common in terms of how they are implemented, but they will be able to recognize each other and communicate by beaconing to share the frequency spectrum.

WiMedia is unique in that the market for silicon is larger than any single digital radio has been. It is capable of distributing digital video around a room and can be small and low powered enough to fit in portable media players and mobile phones. It is also simple enough to replace the USB cable used with a digital still camera. The market for replacing cables for PC desktop peripherals is a 'sure thing' as soon as costs are competitive with cables. The cost of entry into the mobile phone market is greater than USB cable replacement, but the volumes can be substantial. While all of these markets are large, the combination of them makes for an unprecedented opportunity.

## Staying single or not?

The major decision an implementer of WiMedia must make is whether to

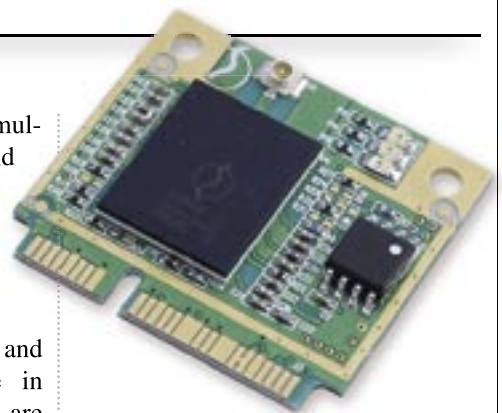

Figure 1. This half mini card, single-sided board shows the low bill of materials and small form factor of a single-chip SiP.

build a single-chip device or a multi-chip device. Traditionally, networking devices are divided into a MAC for media access and the physical (PHY) layer. The WiMedia Alliance has defined a MAC/PHY interface, which presupposes that there will be separate chips for this functionality. If a single-chip implementation is built, it must be able to act as a PHY since interoperability testing has been done at the PHY level. The split between MAC and PHY as separate devices is an artifact of WiMedia's history when UWB was seen as an alternative PHY to an existing IEEE 802.15.3 MAC.

WiMedia uses orthogonal division frequency multiplexing (OFDM) as its modulation technique. WiMedia also requires mandatory AES encryption that can be considered as part of the MAC or baseband, depending on implementation.

A WiMedia system is comprised

of a number of components, including the radio transceiver, baseband, media access controller, and non-volatile memory (NVM). Each of these components is necessary to build a WiMedia product, but whether each block constitutes a separate chip, several chips are combined in a module or everything is built into a single chip or package is an 'implementation detail.'

Today, the RF function is built in SiGe though some companies have sought out a CMOS implementation. A single-chip solution is where RF and digital components are in CMOS and reap the benefits of lowest-cost and smallest form factor (Figure 1).

Some RF implementations have chosen to exploit multiple antennas. The number of external RF components varies by implementation. Some vendors do the RF matching with passive components on a circuit board, others embed the passive elements in a low-temperature co-fired ceramic (LTCC) substrate. The resulting package is called a system in package (Figure 2).

There are many variations in host I/O interfaces. PCI, PCIe, SDIO, USB host, USB device and proprietary interfaces can be found in various implementations. Each of these physical I/O interface standards requires that the MAC speak protocols associated with these interfaces.

WiMedia radios are capable of simultaneously running several different over-the-air protocols. Certified Wireless USB, WiMedia's WiNet and Bluetooth 3.0 are examples of protocols that are defined or in the process of definition. Some applications will use proprietary protocols embedded in the WiMedia frame structure. Others implement the WiMedia MAC with a general-purpose processor and multiple



Figure 2. An example of a system-in-package.



Figure 3. This add-on card from Staccato Communications, the SDIO card (SC3226R SDIO for native Certified Wireless USB), uses a single-chip CMOS SiP packaged solution.

I/O interfaces. Still others optimize the MAC for a faster time-to-market Certified Wireless USB implementation.

While WiMedia radios are capable of running multiple protocols, they don't have to.

### Size matters

Experience with Bluetooth and WiFi suggest that the least-expensive solution that can meet the specification and satisfy user expectations will win the majority of the market. There may be a niche market for high performance, but price is the major factor.

Consider, for example, that mobile devices demand low power consumption and small packages. Here, price is important.

In the shorter term, the first devices to ship will be devices for desktop and notebook PCs and powered Certified Wireless USB hubs. The early devices can afford to burn more power and can be larger. There is room for passive components in a wireless USB hub.

The digital still camera lies somewhere in between. Size is important, but cameras only turn on the radio when sending pictures to another camera, a PC or a printer. Digital still cameras are expected to be early adopters

of WiMedia-based solutions.

The driving force behind early adoption into mobile devices will be solutions implemented as add-on cards (Figure 3). Of course, the trend is toward smaller, cheaper packaging. Ultimately, low-cost and low-height packaging will use standard IC packaging technology. Examples include quad flatpack no-lead (QFN), or micro-lead frame (MLF); ball grid array (BGA); land grid array (LGA); and wafer chip-scale packaging (W-CSP).

Today, SiPs are based on LTCC and will move to stacked die in the near future. The details of how these packaging technologies work are not relevant.

The important issue is that packaging technology is advancing just as Moore's Law is lowering the cost of CMOS chip production. The mobile phone industry is demanding smaller packages and better RF performance with miniscule power consumption.

### Conclusion

For the foreseeable future, Moore's Law and evolving packaging technology are conspiring to make a rosy future for WiMedia. Moore's Law allows more complex digital devices, but as transistors get smaller it becomes possible to support higher frequencies with CMOS implementations. As more functionality is pressed into single-chip packages, automated testing becomes easier, as does automated assembly. Expect to see WiMedia evolve to better performance at lower prices and into more products.

While there may be some market acceptance for first-generation WiMedia products based on multichip solutions, the trend will be toward single-chip, low-power, low-cost solutions in small RF-efficient packages fabricated entirely in CMOS. **EW**

### ABOUT THE AUTHOR

Billy Brackenridge is a product systems architect at Staccato Communications.

# Understanding WiMedia Association models and security

Learning from mistakes of the past, the WiMedia Alliance has forged a secure future for UWB.

By Preston Hunt

**S**ecurity has been a prominent issue for wireless technology. The computing industry's track record has not been good. Attacks and vulnerabilities seem to occur every few months, leading to consumer distrust and slower mainstream adoption of wireless technology. From day one, the WiMedia Alliance set out to learn from past mistakes and to provide a common radio platform with a security solution that would meet users' needs. Recognizing the pitfalls of having multiple levels of security, for example, it sagaciously required all devices to have mandatory security support. WiMedia's goal was and is clear: "keep the bad guys away from users' stuff while not being too hard to use."

While numerous properties have been addressed by WiMedia, this article will focus on the encryption and authentication properties of security. WiMedia security is separated into two parts. Association is performed at the application layer for the first-time setup. Once products have been set up, ongoing operational security is provided by the WiMedia Common Radio Platform. More details on each are as follows:

■ **Operational security.** The ongoing operational security is the same for all protocols based on the WiMedia Common Radio Platform: All data packets for secure products are encrypted at the MAC level using the advanced encryption standard (AES), which is approved by the U.S. government. Encryption and decryption occur in hardware at the full line speed of 480 Mbps, with no significant overhead or delay.

■ **Association.** While ongoing operational encryption is uniform for WiMedia products, the association process for first-generation products will be protocol-specific. Wireless USB and WiNet have custom association protocols that provide security for their respective needs. When Bluetooth and Wireless 1394 release their WiMedia-based products, they will likely use a protocol-specific association method. The reason for these incompatible solutions is that designing security systems is hard work. The development of a single, generic architecture to meet everyone's needs would take longer and cost more. Although each protocol has a specialized association method that is not binary compatible, the user experience for all association methods is similar and consistent.

One of the most important aspects of association is that all WiMedia products require permission from the user before they are allowed to connect with other products. Without this requirement, products would try and connect with one another all the time—frustrating users and posing a security

risk. Mandatory user interaction requires additional steps from the user for device setup, and it will require increased cost to provide display and input capabilities. However, the security and usability benefits far exceed the associated costs.

## Association protocols

Wireless USB products can be associated using one of two methods. In the numeric association model, a device will show a short number (two to four digits) on its display, which the user will verify with the host. On limited hosts that do not have input capabilities, the host displays the number to the user and the user clicks "ok" if the numbers match. Alternately, hosts can ask the user to enter the number. The cable association model allows the user to associate a device to a host by using a USB cable during the first use. After this one-time action, the host and device will remember each other and communicate wirelessly. Host manufacturers are required to implement both models to ensure that all Wireless USB-branded products can associate with each other.

The association protocol used for Wireless USB could not be reused for WiNet because WiNet is a peer-to-peer networking technology. In contrast, Wireless USB is a host-centric peripheral technology (see the sidebar, "WiNet Basic"). The absence of a central controlling host and the possibility of belonging to multiple simultaneous groups led the WiNet authors to adopt the same protocol used by the Wi-Fi Alliance for setup, Wi-Fi protected setup (simple config). While the protocol used by WiNet is the same as the Wi-Fi protocol and binary compatible, it is a separate implementation and not bound by the Wi-Fi Alliance rules.

The simple config protocol is an extensible framework that can support multiple association methods, including USB flash drive, PIN entry, near field communication and Ethernet. In order to make WiNet association as similar as possible to Wireless USB, the decision was made to augment simple config with a numeric comparison method similar to the one used by Wireless USB and Bluetooth. This will ensure a common user experience among WiMedia products. The other association methods supported by simple config will not be used in the initial WiNet release. The extensibility of the framework ensures that they will remain as options should the need arise.

The WiMedia and Bluetooth organizations worked closely to ensure maximal user experience consistency for association. The upcoming Lisbon release of the Bluetooth



protocol will include security enhancements. In addition, Bluetooth supports a numeric comparison method in which the user compares six-digit numbers. When Bluetooth releases products based on the WiMedia platform, the usability of all WiMedia products will remain consistent.

### WAM 2.0: The future

Despite improvements in wireless security promulgated by first-generation WiMedia devices, there is room for improvement. Starting in 2007, the WiMedia Association Models Working Group will begin work on the Wireless Association Models (WAM) 2.0 specification. The goal is to achieve binary protocol compatibility for existing and future protocols based on the WiMedia platform, including Certified Wireless USB, WiNet, Bluetooth and Wireless 1394.

In addition to ensuring 100% user consistency, binary compatibility will reduce the implementation cost on manufacturers. Because the design and implementation of security systems is prone to error, the use of a common code base will allow developers to focus their efforts on building products without worrying about the security subsystem. Also, the security analysis and review can be focused on the single code base instead of spread among multiple implementations.

Unifying the code base is one benefit of WAM 2.0. Another feature will be the addition of association methods that may increase the usability and security of WiMedia products. Foremost among these potential improvements is the adoption of near field communication, a short-range RF technology.

### Conclusion

The security and association solutions provided by WiMedia are a balance of cost, usability and security. The data encryption capabilities built into the WiMedia platform provide protection against eavesdropping of information sent over the air. The association techniques for first-time setup, most notably the numeric comparison method, ensure that products will be reliably and securely connected, with minimal chance that an attacker can intercept the connection. With this security, WiMedia products will be built for success. **EWT**

#### ABOUT THE AUTHOR

Preston Hunt is a technology marketing engineer for Intel's Wireless USB & UWB group. He is also the chairman of the Wireless USB Association Models Working Group and chairman of the WiMedia Association Models Working Group.

## WiNet basics

WiMedia's networking specification is called WiNet and can be referred to as a protocol adaptation layer (see the figure). It acts as the interface between higher-layer networking protocols and the WiMedia media access controller (MAC). WiNet defines a logical link control layer networking protocol for the WiMedia radio platform to model the behavior of an IEEE 802 network. This facilitates easy migration of applications compatible with an IEEE 802 environment to a WiMedia environment with few or no changes. For example, a TCP/IP protocol stack designed for an IEEE 802.3 (Ethernet) environment will work with a WiMedia environment. The WiNet protocol preserves the IEEE 802 headers to facilitate the design of bridges between a WiMedia network and other IEEE 802 or compatible wired or wireless networks.

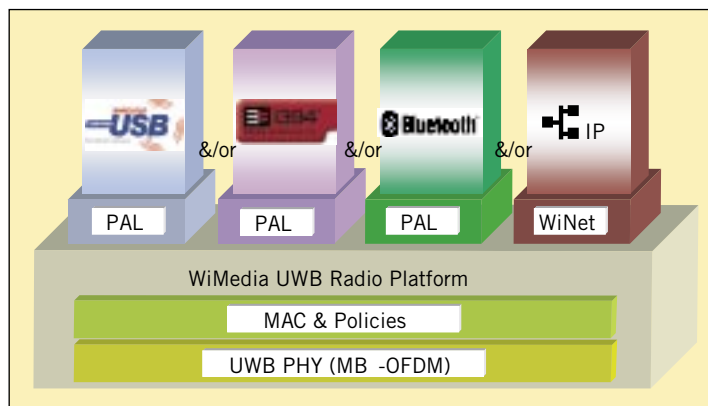

PAL: protocol adaptation layer.

Since WiNet is designed for TCP/IP, it maintains support for the routable nature of Internet applications, meaning that WiNet packets contain a device address as well as a network address. Mobile WiNet devices are designed to communicate with the Web using standard Internet routers.

WiNet is a true peer-to-peer protocol, meaning that devices may communicate with each other directly. This facilitates the creation of ad-hoc wireless personal area networks (WPANs) for mobile devices and applications. Bandwidth is not reduced by the requirement for devices to transfer data through an intermediary node, such as an access point, master or host.

In WiNet, bridging to other networks is based on IEEE 802.1D. This avoids a potential legacy issue of requiring two classes of devices: those that are bridge-aware and those that cannot operate in a bridged environment. WiNet provides control messages that allow devices to select the level of bridge-forwarding services that are desired. Bridge service requests allow a device to designate which packets should be filtered based on protocol identifiers and multicast addresses. WiNet also allows devices to omit the 802 headers for more efficient data transfer if the packets are destined for WiMedia wireless network.

Another major feature is a new advanced hibernation algorithm, which makes use of mechanisms already built into the MAC. While the MAC has an information element that announces when a device will hibernate, there is no way for a set of devices to coordinate their sleep cycles. WiNet defines a local cycle, which allows a device to announce when it will be active. It further defines a global cycle, which is used to synchronize neighbors' local cycles. This hibernation scheme allows devices to conserve power when their data transfer requirements are low.

As an added benefit, WiNet is fully complementary with 802.11 and 802.16. Consequently, it can be used to extend the local area network (LAN) and the metropolitan area network (MAN) to the WPAN space.

#### ABOUT THE AUTHOR

Alan Berkema is an engineer scientist at Hewlett Packard.

# Understanding ATE production test

With careful test strategy consideration, semiconductor companies can achieve product quality and cost aspirations for the UWB market.

By Kyle Klatka

**W**hen introducing any product to market, a semiconductor company strives to deliver its customers the highest-quality solution so they continue to place orders. The introduction of ultrawideband (UWB) technology into high-volume production presents challenges beyond those typically associated with a product introduction. First, UWB's RF spectral characteristics present new test and measurement complexities compared to typical RF production tests for cellular transceiver or connectivity devices. Second, some industry observers anticipate rapid UWB market adoption, which could result in a steep time-to-volume ramp and ASP compression. These conditions set the stage for competing operational objectives. On one hand, there is a need to add capability and potentially cost, to a typical RF production test solution. On the other hand, companies are trying to reduce the cost to test each device. The test strategy for UWB devices, therefore, should include an automated test equipment (ATE) platform that offers engineers the flexibility to adjust fault coverage as needed and efficient multisite testing.

ATE test and measurement challenges for UWB include frequency band coverage up to 10.6 GHz and a 512 MHz RF channel bandwidth. Depending on the chipset's feature set (e.g., onboard PCIe port), level of integration (e.g., single-chip solution), and electrical access (e.g., access between RF and baseband), the test plan might include basic per-pin testing such as continuity and current leakage, device-specific parametric measurements and RF tests.

A typical test list for the RF transceiver block may include power/gain test; 1 dB compression point; IP3; spurious emissions; gain flatness; noise figure and IQ imbalance.

The RF test list and approach can vary depending on the level of fault coverage and performance validation desired, versus the cost to enable these tests. If built-in self-test (BIST) capabilities have been designed into the device-under-test (DUT), this contributes to the discussion. During the initial phase of the production ramp, the test list may include a more comprehensive list than shown above and appear similar to the characterization test list, including a full suite of modulated and continuous wave (CW) parametric tests. A characterization-centric test list typically offers increased device performance validation and manufacturing visibility.

When polling operations managers responsible for the ramp of a UWB device or devices, three goals were consistent in their feedback—minimize cost, minimize cost and minimize cost. While the test list is likely to change as a result of product design and process stability, the ATE platform must be designed for multisite testing and enable high parallel efficiency to reduce the cost of testing each device. Parallel efficiency can be calculated with the following formula:

$$\text{Efficiency} = 1 - \left[ \frac{(\text{MT} - \text{ST}) / (\# \text{sites} - 1)}{\text{ST}} \right]$$

where: MT = total multisite time

ST = single-site time

The highest efficiency occurs when the total test time for a multisite program is the same as a single-site test time.

While it is critical that the ATE

platform offer instrument modules that align to the technical needs, the test program's parallel efficiency is more dependent on the overall architecture of the platform. For example, the underlying platform architecture needs to enable simultaneous instrument set up and settling, instead of sequentially incurring these tasks. Also necessary to increase parallel efficiency is the ability to perform any additional mathematical signal analysis and measurement computation in the background or while the instrumentation continues executing the measurement test list. To reduce test program development time, the software should be designed such that additional device sites (e.g., the number of devices on a single dual-independent bus (DIB)) can be added easily to the program.

UWB's physical layer RF characteristics present several new challenges for semiconductor test. Plus, the forecasted market adoption could result in an unprecedented time-to-volume curve for operational planning and test engineering organizations. With careful test strategy consideration, semiconductor companies can achieve product quality and cost aspirations for this new product segment. Consider developing a test strategy that enables the flexibility to adjust fault coverage and maximize confidence in the quality of the product, while also reducing the cost of test through efficient multisite testing. **EW**

## ABOUT THE AUTHOR

Kyle Klatka is a product manager at Teradyne where he is responsible for wireless broadband test products. He holds a B.S.E.E. and a B.S. in Economics from Georgia Tech.

# A look at the worldwide regulatory process

While it remains to be seen if a common harmonized spectrum for multidevice interoperability will prevail, most major geographies will have some spectrum opened up in 2007.

By Roberto Aiello and Jeff Foerster

The regulatory process for making UWB systems commercially available has taken a long road inside and outside the United States. Started in 1998, the U.S. regulatory process for UWB was completed in 2002, allowing UWB transmission in the 3.1 GHz to 10.6 GHz range. Subsequent updates followed, including a clarification that allowed multi-band orthogonal frequency-division multiplexing technology to operate at normal operating power levels. This decision was the result of a series of interference studies provided by proponents and critics. Both factions supplied the data required by the Federal Communications Commission (FCC) to issue a set of rules to encourage technology innovation and protect the incumbent systems from interference.

Today, the worldwide regulatory process is still under way. International regulatory bodies continue discussions and interference studies to determine the best rules for meeting the requirements in their geographic regions. One of the differences is that many countries have allocated spectrum for fixed services/WiMAX systems in the 3.4 GHz to 3.8 GHz region. Since these fixed services/WiMAX systems can be placed in close proximity to UWB-enabled devices, there is a potential interference concern. Some studies show that UWB emission at the FCC levels of  $-41.3$  dBm/MHz has the potential to create interference to those services in this part of the spectrum.

In an effort to harmonize the spectrum, while not posing interference to these fixed

services/WiMAX systems operating in the 3.4 GHz to 3.8 GHz range, the concept of 'detect and avoid' (DAA) was proposed. This concept mandates UWB devices to reduce the level of emission in that band when they detect a nearby narrowband system. It has been promoted in Japan, Korea and Europe as a possible solution to allow existing and future services to share the spectrum below 5 GHz with UWB devices. In order to support the application requirements and future evolution, UWB systems require spectrum below 5 GHz and above 6 GHz. Products operating in the spectrum below 5 GHz will enter the U.S. market first. Products operating above 6 GHz will be introduced shortly thereafter in other geographic regions.

Japan is the only country outside the United States to issue spectrum regulations for UWB devices. An important part of the regulations is the immediate allocation of the 4.2 GHz to 4.8 GHz band that doesn't require DAA for a period of time (until Dec. 31, 2008 in Japan). Other parts of the spectrum that require DAA will be opened after the mechanism is defined. As shown in the figure, the Japanese mask differs from the European mask in two ways:

1. DAA may be required for all frequencies below 5 GHz starting in January of 2009 while Europe is considering allowing transmission-

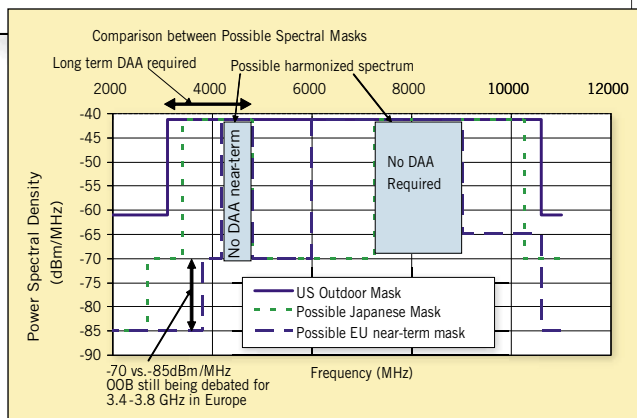

The graphic compares the Japanese emissions mask to the mask being considered for Europe as well as the one adopted by the United States.

without DAA until 2010-2012.

2. The lower limit for the band above 5 GHz starts at 7.25 GHz rather than 6 GHz. This lower limit will make it difficult to develop a single harmonized radio able to operate worldwide.

The regulations for DAA are still being defined and must be proven to work before regulators will adopt them. Other geographies are in the process of regulating UWB, including Canada, Korea and China. From a UWB industry perspective, a common harmonized spectrum would enable multidevice interoperability in any geography and increase the adoption rate of the technology. Regardless, it is becoming apparent that most major geographies will have some spectrum opened up in 2007 to allow for the introduction of UWB on a worldwide basis. **EWT**

## ABOUT THE AUTHOR

Roberto Aiello is the founder and chief technical officer at Staccato Communications. Jeff Foerster is an engineer with Intel Architecture Labs at Intel Corporation.

# Ensuring Wireless USB quality assurance

These five steps can help manufacturers ensure a positive experience for users of products based on Wireless USB.

By Mario Pasquali

As a technology, USB enjoys an excellent reputation. With millions of USB devices sold, users are confident that they can connect any USB peripheral to their PC and have it work immediately. Users will expect this same ease of operation and high level of interoperability from Wireless USB. In order to ensure that their products are commercially successful, manufacturers will need to deliver on these expectations. This means that manufacturers must test their products during development and production.

## Five key steps

The following five steps play an important role in any manufacturer's Wireless USB quality assurance program:

**1. Design in interoperability.** A source of technological risk when working with emerging technology is that specifications are subject to misinterpretation. Clever developers "design in" interoperability from the beginning by testing prototypes against a protocol analyzer instead of connecting two prototypes back-to-back.

Back-to-back testing saves the purchase of an analyzer, but costs more in the long run since it takes longer to find and fix protocol errors. A high-quality Wireless USB analyzer should have been validated against many products from major industry players. This means that the analyzer can automatically detect errors and display any misinterpretation of the Wireless USB specification—

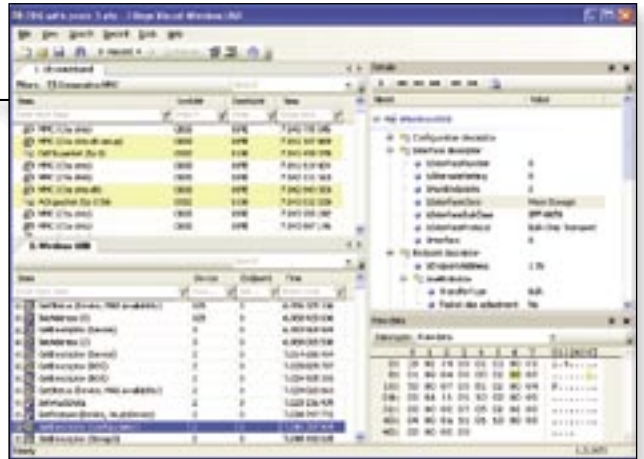

Figure 1. Shown are various UWB and corresponding Wireless USB decode views that are possible using the Ellisys Wireless USB Explorer 300 solution.

thereby avoiding common interoperability errors and improving the chances of passing certification tests.

Because the Wireless USB protocol is quite different from USB 2.0, developers need an interface tailored to Wireless USB with multiple views that show all protocol levels. Developers will also want to be able to display how the Wireless USB protocol is transmitted over UWB to verify low-level detail such as timing (Figure 1).

Some analyzers interpret and display Wireless USB in the same way as USB 2.0. This lets developers learn the new protocol thanks to their previous knowledge.

**2. Reproduce error scenarios to ensure resolution.** Nothing is harder than resolving intermittent errors without the proper tools. When this happens, the usual testing procedure is to capture data until an intermittent error

« We received the protocol analyzer and the guys love it. They're fighting over it in the lab! »

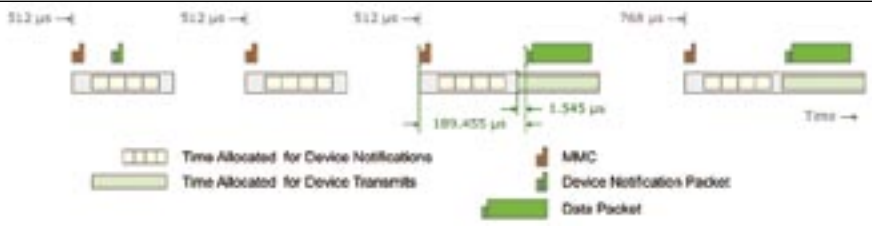

Figure 2. The Ellisys Wireless USB Explorer 300 protocol analyzer provides the user with an InstantTiming view—in this case, a view of Wireless USB micro-scheduled management command (MMC) timing.

occurs, analyze what happened and then design a fix. But how do developers ensure that the fix worked? If the problem doesn't re-occur, most developers assume everything is fine.

There is a better way. If the analyzer has traffic generation capabilities, create a script from captured traffic to reproduce the error scenario. Then, replay the scenario as many times as needed to understand and correct the problem.

**3. Optimize Wireless USB device battery life.** Wireless USB has a sophisticated power management scheme designed to maximize the battery life of portable devices. Unfortunately, this scheme is too complex to explain here. Readers can download "Migrating to Wireless USB" at [www.ellisys.com](http://www.ellisys.com).

Successful power management requires powering down the radio as much as possible, thereby decreasing the average power consumption to extend battery life. However, poor RF design or improper protocol implementation can cause the opposite to occur, powering on the radio for excessive retransmissions. Use of a protocol analyzer with visualization capability measures timing and performance to help understand which parameters can be improved (Figure 2).

**4. Characterize the overall transmission quality.** A Wireless USB link is theoretically more prone to errors than a USB link using a shielded cable. Not only are longer packet lengths preferred in wireless medium to optimize throughput and reduce overhead, but Wireless USB will be used by peripherals that exchange large amounts of data. Unfortunately, the longer the packet length the greater the probability of a data error. These two factors combined—a higher inherent data error rate and long packet lengths—present a serious engineering challenge that can negatively influence usability.

RF performance can be affected by design factors,

including the antenna, RF chip and printed circuit board layout. Designers need a reliable setup to understand the impact of their 'tweaks.' A traffic generator is helpful. Connect the device-under-test to a traffic generator and exchange a known sequence of frames

between the units. Then, verify that the frame error rate is in the acceptable range. Repeat the test at different data rates to characterize the RF transmission quality as well as the device's performance. Next, use the same setup with a variable attenuator connected between the UWB traffic generator and its antenna. Increase the attenuation to simulate increasing the distance between the two units.

**5. Validate the proper operation of production units.** Manufacturers' production test beds need to be upgraded with UWB transmission testing. It is impractical to validate production units by using a manual procedure. A more efficient alternative is to program a traffic generator to produce a known scenario suitable for the product in question. This sequence is then used to verify the proper operation of production units. Note that for this process, a traffic generator with a programming interface is needed in order to integrate it into the manufacturer's setup.

### Summing it up

Quality gurus know that quality assurance (QA) is a philosophy that encompasses product development through production. The steps just described will help developers and QA engineers ensure that their Wireless USB products pass certification tests and are accepted by customers. In turn, high-quality USB peripherals with outstanding wireless capabilities will create opportunities for manufacturers. **EWT**

### ABOUT THE AUTHOR

Mario Pasquali is the co-founder of Ellisys, a test and measurement company committed to the design and timely introduction of advanced protocol analysis solutions for USB devices, Certified Wireless USB and UWB. For more information on designing Wireless USB interfaces, download "Migrating to Wireless USB" at [www.ellisys.com](http://www.ellisys.com).

## Leaders choose Ellisys.

Find out more on [www.ellisys.com/customers](http://www.ellisys.com/customers)



ellisys

USB and UWB Protocol Test Solutions

# Timely WiMedia solutions fuel UWB Ecosystem expansion

Earlier wireless support lessons prove valuable, but the timing of resources is more critical than ever.

By Mike Tanahashi

As the name implies, today's "ultrawide-band (UWB) Ecosystem" forms a complex network of processes and organizations working together to provide a total customer solution. Experience shows that most OEMs prefer to integrate the modules they procure from their suppliers. This is especially true when introducing state-of-the-art wireless technologies requiring a completely new test setup for in-house certification that may be impacted by different regulatory requirements for each country or region. However, most OEMs are now looking for a "one-stop-solution provider" to help them simplify the development process, ensure smooth and reliable implementation and shorten the time to market.

## Silicon development efforts

Silicon manufacturers, having spent significant resources to develop highly advanced UWB solutions, often find it challenging to integrate their silicon into customer applications. Realizing the importance of a well-established Ecosystem prior to customer implementation, some early WiMedia Alliance members have worked to proactively study and understand UWB technology. They also helped to define the specification at the earliest stages and have remained in close contact with each silicon manufacturer to better optimize their

respective solutions.

In some cases, solution providers like Taiyo Yuden were able to apply expertise gained during the Bluetooth module development and certification experience to the requirements of UWB Ecosystem support. This entailed the development and optimization of front-end passive devices such as miniaturized ceramic chip antennas, bandpass filters, baluns, complete modules and other elements (see the figure). Since the Bluetooth SIG has opted to work with the WiMedia Alliance to define the high-speed Bluetooth technology specification, it seems obvious that UWB will soon be implemented in battery-operated, handheld applications requiring miniaturized module solutions, such as with cellular phones.

Silicon manufacturers are introducing chip-scale package (CSP) options that will help manufacturers optimize

solutions such as highly integrated low-temperature co-fired ceramic (LTCC) modules into small form factors. Antenna requirements, another critical function for Ecosystem support, are seeing WiMedia providers respond with commercially available ceramic chip, film, printed circuit board (PCB) and other antenna technologies targeting specific applications.

Challenges still remain, however. For example, different wireless technologies may be implemented in the same end device, but each may require its own antenna. At this stage of the technology, all frequency bands cannot use the same antenna. It is only a matter of time though, before this technological hurdle is surpassed.

## A parallel development

Unlike earlier wireless system implementations, the WiMedia Alliance



*WiMedia UWB Ecosystem support optimizes OEM time to market through a full range of hardware and software elements—including passive components, front-end devices and modules—all the way through the necessary measurement and certification processes.*

# OMNIYIG INC.

Since 1973, OMNIYIG has been at the forefront of advanced YIG technology, manufacturing state-of-the-art YIG components, Detectors, Limiters, Comb Generators, and integrated subsystems. The standard products shown here represent a fraction of our total capabilities. We are involved in a critical mission continually designing and manufacturing new state-of-the-art YIG components for Airborne Systems / Space / Ship Board Commercial / EW / ECM / Jammers / Radar / Communication.

OMNIYIG's products are available for commercial use, yet are built under stringent military specifications (MIL-E-5400) Class II/MIL-STD-883 (Typical). Our advanced products are designed into some of the world's most sophisticated systems, including commercial, EW, and ECM programs such as the ALQ-99, ALQ-117, ALR-172, ALR-56C, ALR-62, ALR-64, ALR-67, ALR-69, APR-39, WLR-8, Rapport III and we are on board the F-15, F-16, F-18, EA6B, EF111, B-1, B2 Stealth, L-130, Toronado, Space Systems and more. We maintain and continue technology improvement.

Whether you are interested in new Yig Devices, Semiconductor components, state-of-the-art components, updating existing systems, or integrating new systems, OMNIYIG's Engineering staff can assist you with your design requirements as we have done for over 1000 different companies and 30 countries.



## YIG OSCILLATORS

Omniyig Model No.	Freq. Range (GHz)	RF Pwr. Out. (mW)	2 <sup>nd</sup> Har. (dBc)
YOM1517	00.5 - 02.0	20	15
YOM1518	01.0 - 04.0	20	15
YOM3597	02.0 - 08.0	20	12
YOM105	02.0 - 18.0	2	40
YOM1949	03.0 - 10.0	20	10
YOM1986	03.5 - 12.4	20	10
YOM1515	04.0 - 18.0	10	10
YOM1516	06.0 - 18.0	20	10
YOM818	08.0 - 18.0	20	12



## YIG FILTERS

Omniyig Model No.	Freq. Range (GHz)	Ins. Loss (dB)	Bandwidth @ 3 dB (MHz)
<b>4-STAGE</b>			
S104	02.0 - 04.0	4.0	20-35
C104	04.0 - 08.0	4.0	25-40
X104	08.0 - 12.4	4.0	25-40
Ku104	12.4 - 18.0	4.0	28-45
<b>6-STAGE</b>			
C106	04.0 - 08.0	4.5	25-40
X106	08.0 - 12.4	4.5	25-40
Ku106	12.4 - 18.0	4.5	28-45
<b>DUAL 4-STAGE</b>			
C1044	04.0 - 08.0	5.0	25-40
X1044	08.0 - 12.4	5.0	25-40
Ku1044	12.4 - 18.0	5.0	30-60
M1044	02.0 - 18.0	5.0	25-60

Many other custom unit designs are available. Integratable with Analog or 12-bit TTL drivers.

# OMNIYIG INC.

3350 Scott Blvd, Bldg. #66, Santa Clara, CA 95054  
Phone: (408) 988-0843 • Fax: (408) 727-1373  
omniyig@us.netcom.com • www.omniyig.com



Delivering the Highest Quality of Technology for over 32 Years. **Since 1973**

has successfully worked from the start to develop a total Ecosystem in parallel to silicon development, such that optimized antenna solutions are available. For example, PC manufacturers may implement UWB/Bluetooth dual-physical layer (PHY) solutions using a readily available broadband antenna that accommodates both bands with a single device.

The requirement for small form factors, omnidirectional patterns needed by portable devices, wide bandwidth, high gain and efficiency, and flat group delay over wide bandwidth are all major antenna design considerations that must be solved by Ecosystem providers. Another difficult challenge, broadband filter design, may be appreciated by comparing the ratio of bandwidth to center frequency, as follows:

$$rbw = Bw/Fc,$$

where rbw = bandwidth ratio; Bw

= pass bandwidth and Fc = passband center frequency. The higher the rbw, the more difficult the design. Compared to an rbw of 4.1% for the 802.11b standard, first-generation, low-band UWB solutions call for an rbw of 40%.

External filters, as opposed to silicon-based solutions, are required to achieve this level of result. And, once the design know-how has been obtained, it is relatively easy to provide the filter solution for a specified spectrum mask. For example, a band-pass filter for WiMedia Band Group 1 TFC7 (4224 MHz to 4752 MHz) was recently developed and optimized by Taiyo Yuden for the spectrum mask in Japan. This solution will fast-forward many OEMs through the Telecom Engineering Center (TELEC) approval process in that country. By having access to certified or certifiable UWB module solutions, OEM customers

will typically require no additional RF test facility approvals—thus greatly shortening time to market.

In addition to the certifications required by various organizations to sell UWB products in the global market, proof of interoperability is also critically important. Finally, any supplier that would be a player must be ready, willing and eager to invest the resources required for a substantial ongoing support commitment, including world class R&D, manufacturing and distribution. The market deserves—and demands—no less from a rapidly expanding universe of UWB Ecosystem solutions providers. **EW**

#### ABOUT THE AUTHOR

*Mike Tanahashi is the manager of the development planning department of Taiyo Yuden Co., Ltd's R&D division. For further information, contact mtanahashi@jty.yuden.co.jp.*



## For those subscribers who buy...

You can access our Buyers Guide online at [www.rfdesign.com](http://www.rfdesign.com)



# Testing WiMedia-based receivers and transmitters

Testing throughout the implementation stages provides a predictable path to conformance to the WiMedia specification.

By Mark Lombardi

**D**uring the design through certification phases of radios that implement WiMedia-based MB-OFDM UWB technology, testing plays a key role in understanding how the design conforms to the specification. Testing through these phases can help designers understand their device's raw performance with respect to the specification and the margin that is available in the design.

Testing of the physical WiMedia-based radio or PHY can be broken down into two main components: receiver testing and transmitter testing. Much of the testing is focused on the performance of the design with respect to the specification. Other tests explore margins by stressing the design to its absolute limits. This is done as a means of understanding whether the design has headroom that could potentially be used as a differentiator in the marketplace. In particular, this article explores the primary measurements used to confirm the design is performing as required by the WiMedia specification.

The WiMedia specification calls out multiple parameters intended to insure radios produced by various silicon providers will interoperate. Initially, this testing is "conducted," or wired directly to the test equipment, to eliminate the antenna as a variable. In later development stages, when the radios are integrated into products, many of these same tests, along with additional tests, can be performed with a "radiated" setup, which necessitates using an antenna on the test equipment.

The specification outlines multiple transmitter parameters that can be categorized as timing, frequency and modulation requirements. The requirements generally considered the most critical indicators of performance and ultimately interoperability include the following:

- **Time domain measurements.** These measurements can be made by capturing the RF signal with a real-time oscilloscope. Measurements such as zero-padded suffix duration and symbol interval may be read directly from the time capture. Many of the specification requirements are interdependent; therefore, a case could be made to skip many time domain tests. For example, a problem with the timing of a standard preamble's burst length (the requirement is 30 symbols) would likely be detected in error vector magnitude (EVM) testing, which would not decode the preamble properly if it was malformed. However, it is important to realize that the ultimate goal of conformance testing is interoperability of multiple vendors' radios. There are cases where interoperability problems may not be detected due to extra margin in a transmitter or receiver. In this case, the margin may potentially hide a problem in one or the other; thereby reinforcing the value of thorough testing.

- **Frequency domain testing.** One of the first and most obvious tests is verifying that the radio is broadcasting on the specified bands and is within the specified power limits.

Note that this discussion will not cover the regulatory testing that is required for radio operation in various regions of the world. Regulatory testing uses a different set of tools—mainly narrowband spectrum analyzers—which enable the very low-noise measurements needed to verify the low-power-level restrictions imposed on UWB technologies. These tools do not allow for modulation domain testing of WiMedia-based technologies. And, because they are swept measurement tools, they cannot measure the individual band performance of these signals as they hop. WiMedia-based frequency and modulation domain measurements are performed by using a high bandwidth, real-time oscilloscope as the digitizer and vector signal analyzer software for the measurements.

The key frequency domain tests required to verify that a radio is designed to the WiMedia specification are frequency tolerance, power spectral density (PSD) testing, adjacent-channel power ratio (ACPR) and transmit power control (TPC). These tests are performed on the transmitter and are strong indicators of (what kind of neighbor the radio will be when) operating in the presence of other radios. Frequency tolerance tests help ensure the radio is transmitting within the frequency offset capabilities of the receiver. PSD and ACPR tests help insure that radios operating in the same band group do not have artifacts that would cause

*Continued on page 27*

# A closer look at UWB regulatory testing

There are many challenges to testing UWB equipment, having a clear understanding of the regulations, therefore, is crucial.

By Pat Carson

In the United States an ultrawideband (UWB) radio must comply with part 15 of title 47 Code of Federal Regulations, 47 CFR. Part 15 deals with unlicensed devices while subpart (f) specifically covers UWB transmitters. Subpart (f) describes several classes of UWB equipment such as ground-penetrating radar, through-wall imaging systems, and handheld/portable and stationary communication systems. It is these communication systems that we are interested in and are referenced as 47 CFR 15.517 indoor UWB systems and 47 CFR 15.519 handheld UWB systems.

In May 2000, the Federal Communications Commission (FCC) issued a Notice of Proposed Rulemaking to amend part 15 of the commission's rules. This move was intended to pave the way for new types of products incorporating UWB technology. After nearly two years of comments and controversial proceedings, the commission issued the First Report and Order allowing the marketing and operation of products that incorporate UWB technology. In 2004, the first UWB communication devices were tested, submitted and received grants for operation in the United States. These first radios were based on different physical layer technologies: Wisair-based multiband orthogonal frequency-division multiplexing (OFDM), General Atomics spectral keying and Freescale direct sequence. Today, the vast majority of UWB communication devices are based

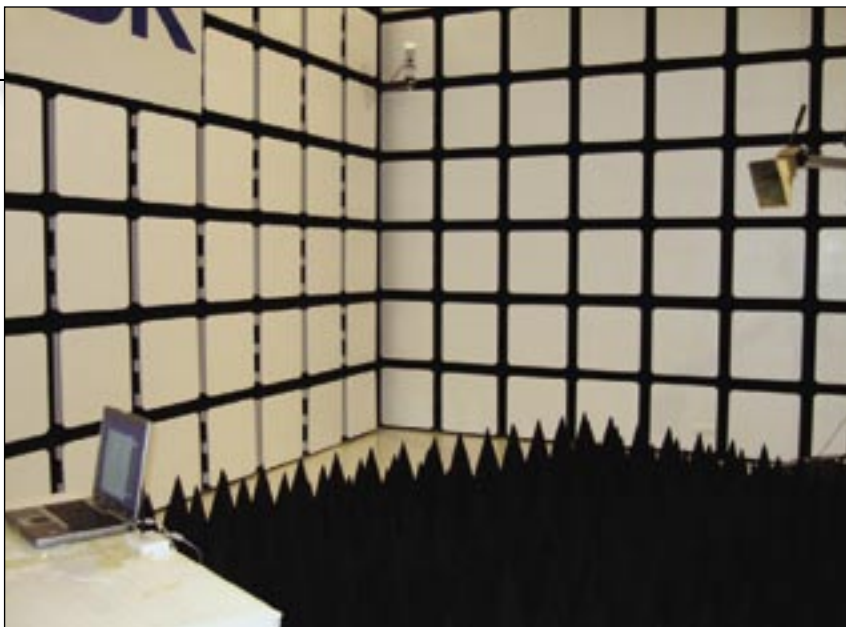

*In this picture, photographed in the author's lab, measurements of a wireless USB hub from WiQuest Communications are being taken.*

on the WiMedia Alliance multiband OFDM standard.

More than four years after UWB products were allowed in the United States, the Japanese ministry that controls radio regulatory issues, the Ministry of Internal Affairs and Communication (MIC), issued regulations allowing the use of UWB technology. Shortly after the MIC regulations were announced, Japan's Telecom Engineering Center (TELEC), issued T406 ([www.telec.or.jp/eng/E\\_T406.html](http://www.telec.or.jp/eng/E_T406.html)), which describes the test methodology for UWB radio systems.

While the MIC may describe other test methods, the methodology between the FCC and TELEC differ substantially in that compliance measurements for the FCC are done in a radiated environment using anechoic or semi-anechoic chambers (see the

figure). In contrast, TELEC prefers conducted measurements if the equipment has an antenna connector. In cases where there is no antenna connector, it allows for radiated measurements. If conducted measurements are performed then performance data of the antenna mounted in the product must also be submitted. Regulations allowing UWB operations are expected soon from other regulatory domains such as Canada, China, Europe and South Korea. Each of these areas is leaning toward conducted measurements similar to the Japanese MIC standard.

In order to determine what regulations apply to a device employing UWB communication systems, each of the radio sections must be considered. There are three main areas of interest in a UWB device: the trans-

mitter, the receiver and the digital control circuitry. The transmitter is the intentional emitter portion and includes the signal generation and filtering required to produce the waveform. The FCC considers the antenna to be an integral part of the radio and specifically requires that the antenna be non-separable. It, therefore, becomes part of the transmitting circuitry. This is not the case for MIC where the antenna can be removed and measured separately. In all cases, the regulations require that any unintentional emissions from the receiver meet the applicable limits and must be tested.

In the case of UWB radios, the digital control circuitry is treated differently than other unlicensed devices. Different limits apply to the control circuits of the transmitter, bus control circuits and clock sequences. One must refer to the applicable sections of the rules in order to apply the correct limits and procedures. It is also important to remember that peripherals,

support equipment and associated cabling must be included in the measurements, since often times, RF couples to the external ports and can radiate, or conduct, through the cables and radiate. For specifics to equipment spacing, table height and cable routing, refer to the ANSI C63-4 standard, Methods of Measurements of Radio Noise Emission from Low Voltage Electrical and Electronic Equipment ([www.ANSI.org](http://www.ANSI.org)). Another document from the International Electrotechnical Commission, IEC60489, should be consulted for specifics on antenna gain measurements ([www.iec.ch](http://www.iec.ch)).

There are many challenges to testing UWB equipment. Since the emission levels and limits are very low and frequencies very high, specialized equipment (low noise amplifier's (LNAs), filters, metrology antennas, etc.) must be employed. Special procedures and equipment are also required for measuring peak power in a 50 MHz bandwidth as well as emissions in the

GPS bands and up to 40 GHz. Familiarity with these challenges and procedures will help ensure FCC and TELEC regulatory compliance. **EWT**

For additional information on FCC and TELEC regulatory rules, check out the following resources:

- Information on radio measurements—UWB/Wireless USB kyouk-asyo, Shirou Sakata ed., Impress (2006), Tokyo.

- Detailed treatment of FCC regulator testing of UWB equipment—Ultra Wideband Systems: Technologies and Applications, by Dr. Roberto Aiello, PhD, and Dr. Anuj Batra, PhD.

#### ABOUT THE AUTHOR

*Pat Carson is the vice president of business development of the U.S. division of TDK Corporate Research and Development. He has 20 years experience in strategic business development and marketing of personal communications devices including cellular, WLAN, Bluetooth, and UWB. Carson received his business degree from UC Berkeley.*

#### Continued from page 25

a receiver either working at a fixed-adjacent frequency (TFI mode) or hopping into an adjacent channel (FFI mode) to have reception problems. You can see the importance of the test: a problem here would not affect the “violator” radio, but would cause problems with another radio ther by causing consumers to blame the “victim” radio for the problem. Transmit power control testing helps ensure that the radio will be able to use only the transmitter power necessary for the transfer task at hand. As a result, it helps maximize battery life and minimize RF interference to other co-located radios.

A key modulation domain analysis test for WiMedia-based transmitters (as well as most RF technologies) is EVM. For engineers who might be more familiar with digital testing, this test is analogous to the jitter measurements and eye diagrams used to derive the measurement for a digital signal. As with eye diagrams, EVM constellation diagrams are graphical expressions

and simple numbers representing a compilation of multiple error sources.

#### Receiver tests

These tests are more about testing the “breaking” point of the receiver, as you can only test the ability of the receiver to work under various stress conditions, and are preformed using a special transmitter, sometimes referred to as a “Golden Radio.” This transmitter has fully controllable transmit characteristics and can operate as a clean “ideal” transmitter. It can also be adjusted to have known impairments or distortion. In this way, the margin of the receiver can be assessed.

First, the engineer must determine whether the receiver meets the frequency tolerance of  $\pm 20$  ppm as listed in the specification? Using the golden radio, it is simple to sweep the local oscillator (LO) to determine whether the receiver meets the specification, and to stress it to the point where the receiver starts to fail to determine the design’s margin. Vari-

ous other parameters can be assessed as well. For example, how do you determine the effectiveness of the PSD mask requirement, beyond simulation of the design? Using a golden radio, interference can be injected that mimics the type of design issues the PSD was intended to detect. Then interoperability testing can be performed with this intentionally distorted radio, assessing the impact of this particular transmitter impairment on the receiver.

The WiMedia specification was meticulously engineered to ensure that the technologies built on it provide consumers with a reliable, high-speed wireless experience. Testing throughout the implementation stages provides a predictable path to conformance to the dictates of that specification. **EWT**

#### ABOUT THE AUTHOR

*Mark Lombardi is the UWB business development manager, for the digital verifications division of Agilent Technologies.*

# Standards compliance simplified

Compliance and certification programs are key to the proliferation of UWB technology.

By Brad Hosler

**A** good certification program is a 'must' for any technology that is an industry standard. Examples include Wi-Fi, Bluetooth, PCI and Wired USB. Certification programs consist of a compliance portion that evaluates a product's conformance to the specifications, and an interoperability portion that evaluates a product's ability to interoperate with other products.

Products based on WiMedia's Common Radio Platform provide some challenges for certification because it supports multiple applications and interoperability needs to be demonstrated between products of the same application. For instance, there will be no real interoperability between Wireless USB products and Bluetooth products. However, since the applications are using the same media (e.g., UWB), they do need to coexist and not interfere with each other.

WiMedia's certification program is focused on the WiMedia PHY, and the coexistence portions of the WiMedia MAC. The coexistence testing is called WiMedia Platform certification. Application certification is the responsibility of the application's trade organization. In the case of Wireless USB, for example, that responsibility would fall to the USB Implementers Forum (USB-IF). Applications are expected to require WiMedia PHY and platform certification as part of the application certification.

## WiMedia PHY certification

WiMedia PHY certification consists of two main pieces: compliance tests and interoperability tests. All tests are performed using a conducted connection (e.g., not using antennas). At this point, all testing is done in band group

1, although as PHYs become able to support other band groups, the same testing will be done.

Compliance tests measure a WiMedia PHY's compliance with the specification by using test equipment, primarily a digital sampling oscilloscope (DSO), to measure its characteristics. Such tests include error vector magnitude (EVM)—both full power and reduced power, power spectral density (PSD), adjacent-channel power (ACPR), preamble cross correlation, preamble relative power and Tx power control. They are run across all WiMedia-defined channels.

The interoperability tests measure a PHY's ability to successfully move data to and from a set of 'reference' PHY units. For Tx tests, the PHY transmits to the reference units using various channels, speeds and packet lengths with the power at the receiver being -50 dB. For all tested combinations, the Tx PER requirement is 1%. The receiver of the PHY device-under-test (DUT) is tested in a similar fashion. Reference PHYs transmit to the DUT using various channels, speeds, and packet lengths, as well as diminishing power levels. For the higher power levels, an Rx PER of 1% is required. For lower power levels, an Rx PER of 8% is required.

PHYs that successfully pass the PHY tests become WiMedia registered PHYs. Specifics of all the tests can be found in the WiMedia PHY test specification located in the members area of the WiMedia Alliance web site ([www.wimedia.org](http://www.wimedia.org)).

## WiMedia platform certification

WiMedia platform certification fo-

cuses on an end product's ability to properly execute the WiMedia beacon protocol and the WiMedia bandwidth reservation policy. All tests are done using antennas. The DUT is tested with an interop device (INTD) of its choosing that allows the DUT to do some normal operation. For instance, Wireless USB devices will likely have a PC host as its INTD. Testing is performed with a test system that creates situations for beacon protocol testing and bandwidth reservation testing. The test system artificially creates beacon protocol scenarios with multiple devices by transmitting in multiple beacon slots, as well as bandwidth reservation scenarios to which the DUT must respond. The test system also monitors all packets transmitted and checks them for appropriate formation and timing.

Beacon protocol testing includes the DUT's ability to properly choose a beacon slot and deal with beacon contraction and expansion. It also handles beacon collision and merging of beacon periods. Bandwidth reservation policy testing includes the DUT's ability to properly honor existing reservations and to properly allocate row and/or column reservations.

Platforms that pass the WiMedia platform tests become WiMedia certified platforms. Specifics of all the tests can be found in the WiMedia platform test specification located in the members area of the WiMedia web site.

## Wireless USB certification

Certification for Wireless USB focuses on application-level testing of Wireless USB products. Testing is *Continued on page 34*

# Software considerations around Wireless USB

Along with hardware, software is a major enabler of Wireless USB's overall success.

By Fred Bhesania

It is without doubt that USB has been one of the most successful wired interconnect technologies in the world. Within a decade, this technology has embraced simple devices from keyboards and conference cameras, to highly complicated systems like cell phones and cash registers. The variables that contributed to the popularity of this technology include a simple connector, an empowered industry forum in charge of the specifications and an industrywide compliance and certification program. But there is one major enabler outside of pure hardware—namely the software.

It is this software component that has played a fundamental role in the PC ecosystem to promote the popularity of USB. Operating systems, like Windows XP, support more than 15 class drivers for USB device protocols and the ability to create vendor-extendible software drivers. When Windows originally released support for USB, this was indeed not the case—there were numerous devices that didn't have the infrastructure support or the ease of use. As time progressed and the industry put more importance on the value of software, newer operating systems provided stability and scalability, enhancing the supported list of class drivers and empowering new technologies like Wireless USB to use the same class drivers. As newer technologies like network connected devices have evolved, the word on the street is, "make them work as well as USB."

Wireless has brought consumers a

new sense of freedom: the ability to be mobile, free from cables and to seamlessly connect. This progress in connectivity allows consumers to continue their daily lives without a second thought. While some may believe it's still a dream, the pioneers of ultrawideband (UWB), the WiMedia Alliance, have taken on that specific technology challenge. UWB has the potential to not only cut the cable, similar to technologies like Bluetooth and WiFi, but it also has a unique opportunity to launch from an elevated level rather than ground zero. From the start, WiMedia was faced with a dilemma: should they create a new set of interfaces and spend several years developing new class profiles/protocols, or is there an opportunity to leverage existing models? Analyzing both options, the group decided the best approach was to leverage existing protocols like Wireless USB, IP and recently, Bluetooth.

Leveraging existing technologies makes it easier to write software and reuses standardized interfaces. This is a software developer's dream come true, but the scope of software impacts a number of individuals. While making software easy to develop for software vendors is one hurdle, let us not forget the average end user. The average user wishes to use devices that achieve specific tasks and make their lives easier. Dealing with complex user interfaces and complicated driver installation steps can delay the proliferation of a technology.

When it comes to software, there are

a few key hurdles to overcome. These hurdles can be broadly divided into a few key categories. The first hurdle focuses on initial software installation, standardization and distribution. We all know that after we purchase a new piece of hardware, we need to install the software that comes with it. What if we buy two devices from two different vendors and the software on each CD is incompatible with the other? This is where companies like Microsoft have played a key role in developing and delivering a common, yet extensible software infrastructure. This allows common features to be implemented in a universal way, while allowing partners to innovate and differentiate. The distribution of such new software is a paramount question and once the software is integrated into a mainstream operating system, miracles have been known to happen.

The second hurdle, which is critical for the end user's first experience, is the user interface. Have you ever faced a situation where you have obtained a new device like a PC or a cell phone and not known where to go to 'add a new wireless device' to your ecosystem, or configure the device to turn some features on or off? How often should an end user be subject to learn new terms (which sometimes differ across connectivity) and technologies just to be adept enough to perform some basic functions? A smart and adaptable user interface that is developed with extensive user experience studies can allow a new wireless technology to launch to new heights. Users know how to

use wired USB devices. With Wireless USB, we have an opportunity to make the interface and experience just as simple as wired USB, by expanding on users existing knowledge of USB and adding in necessary infrastructure for association and configuration. The goal is to make Wireless USB easy to use, keep it secure, and enable new scenarios above and beyond existing wired USB scenarios.

For the purpose of this discussion, the final hurdle left for us to overcome is to envision the future of UWB. With unprecedented bandwidth available now and increasing in the future, and additional protocol adaptation layers like WiNet and Bluetooth also emerging, how do we empower software developers to scale to new usages? The same device could use multiple wireless technologies to transfer data, be it Wireless USB, Bluetooth or WiFi. In such complex scenarios, the complexities (introduced by multiple radios and protocols) should be hidden from end users by software. It is only then that software can truly allow UWB users to reach their full potential.

UWB, starting with Wireless USB, lays the foundation for the next decade of wireless connectivity. Software-enabled Wireless USB products will enter the market, leveraging the wireless experiences consumers have with current wireless technologies and the robust class driver support of USB. As the industry moves toward the future, with multiple connectivity technologies on the same device, the software challenges of simultaneously using multiple connectivity technologies, seamlessly transitioning between them and simplified association will be the primary challenges. It is with these challenges in mind that the Wireless USB founders are progressing ahead to evolve a powerful wireless device ecosystem empowered by UWB. **EWT**

#### ABOUT THE AUTHOR

*Fred Bhesania is the Microsoft representative on the USB-IF board of directors.*

## UWB quick tips and resources

The UWB industry continues to make significant strides forward with certifications now under way and a range of products (e.g., components, semiconductors, software and test equipment) based on the technology either already announced or on the verge of being announced. For those engineers interested in obtaining more information about this exciting technology, and the industry that it is helping to define, resources are just a mouse click away. Following is a roundup of excellent sources of information on UWB, WiMedia Alliance, Certified Wireless USB, industry players and products.

### Industry Standards:

- WiMedia Alliance—[www.wimedia.org](http://www.wimedia.org)

The mission of the WiMedia Alliance is to promote and enable the rapid adoption and standardization of UWB worldwide for high-speed wireless, multimedia-capable personal-area connectivity in the PC, CE and mobile market segments. Go to this site for information on specifications, regulatory, marketing, logo, compliance and interoperability for the WiMedia PHY/MAC. Also available is information on delivering Internet protocol (WiNET) over the WiMedia Common Radio Platform.

- Ecma International—<http://www.ecma-international.org/publications/standards/Ecma-368.htm>

Ecma International is an industry association dedicated to the standardization of information and communication technology (ICT) and consumer electronics (CE). Go here for information on WiMedia UWB specifications as well as to obtain a free download of published PHY/MAC specifications.

- USB Implementers Forum—<http://www.usborg/developers/wusb>

The USB Implementers Forum (USB-IF) is a non-profit group of companies that developed the USB specification. USB-IF supports the adoption of USB technology, including Certified Wireless USB—the new wireless extension to USB that combines the speed and security of wired technology with the ease-of-use of wireless technology. Go here for more information on specifications & certification for Certified Wireless USB, based on the WiMedia Common Radio Platform.

- Bluetooth SIG—<http://www.bluetooth.com>

The Bluetooth Special Interest Group is a privately held, not-for-profit trade association. SIG members drive the development of Bluetooth wireless technology, and implement and market the technology in their products. Bluetooth SIG selected the WiMedia Alliance MB-OFDM version of UWB for integration with the current Bluetooth wireless technology. Go here for more information on specifications and certification for Bluetooth 3.0, based on the WiMedia Common Radio Platform.

### UWB Analyst Reports:

- Allied Business Intelligence—[www.abiresearch.com/products/market\\_research/Ultrawideband \(Q2, 2006\)](http://www.abiresearch.com/products/market_research/Ultrawideband_(Q2,_2006))
- IMS Research—<http://www.imsresearch.com/members/pr.asp?X=270> (July 2006)
- In-Stat/MDR Market Research—[www.instat.com/r/uwb/](http://www.instat.com/r/uwb/) (May 2006)
- Market Research—[www.marketresearch.com/map/prod/1267676.html](http://www.marketresearch.com/map/prod/1267676.html) (March 2006)

### Educational Resources:

- UWB University—<http://www.uwb-u.com>
- Articles, presentations, white papers—[http://staccatocommunications.com/press/articles\\_presentations](http://staccatocommunications.com/press/articles_presentations)
- Technical books—<http://staccatocommunications.com/books?title=uwbssystem>

## Corporate Resources:

### Semiconductor:

The following is a list of companies offering UWB solutions. Included are companies that provide the PHY-only, as well as those that provide only the MAC and upper layers. Several other companies, which offer complete solutions, are also listed along with a few who have yet to announce solutions, but are on the verge of doing so.

- Alereon—[www.alereon.com](http://www.alereon.com)
- Artimi—[www.artimi.com/](http://www.artimi.com/)
- Broadcom—[http://www.broadcom.com/careers/wireless\\_design\\_center.php](http://www.broadcom.com/careers/wireless_design_center.php)
- Cambridge Silicon Radio—<http://www.csr.com/pr/pr193.htm>
- Focus Enhancements—[http://www.focussemi.com/products/uwb\\_radio\\_module.html](http://www.focussemi.com/products/uwb_radio_module.html)
- Fujitsu—<http://www.fujitsu.com/us/services/edevices/components/input/uwb.html>
- General Atomics—[www.ga.com/uwb](http://www.ga.com/uwb)
- Infineon—<http://www.infineon.com/cgi-bin/iframe/portal/ep/channelView.do?channelId=-79492&pageTypeId=17099>
- Intel Corporation—<http://www.intel.com/technology/comms/uwb/>
- Mindtree Consulting—[www.mindtree.com/](http://www.mindtree.com/)
- NEC Electronics—<http://www.necel.com/usb/en/wusb/uwb.html>
- NXP Semiconductor—[www.nxp.com/products/connectivity/uwb/index.html](http://www.nxp.com/products/connectivity/uwb/index.html)
- Realtek Semiconductor (Wionics)—<http://www.wionics.com/>
- Staccato Communications—[www.staccatocommunications.com](http://www.staccatocommunications.com)
- Synopsys—[http://www.synopsys.com/products/designware/wiusb\\_solutions.html](http://www.synopsys.com/products/designware/wiusb_solutions.html)
- Texas Instruments—<http://focus.ti.com/docs/solution/folders/print/302.html>
- Tzero—[www.tzerotech.com](http://www.tzerotech.com)
- Wipro—<http://embedded.wipro.com/reusableframeworks/uwb/>
- Wisair—[www.wisair.com/](http://www.wisair.com/)
- WiQuest Communications—[www.wiquest.com](http://www.wiquest.com)

### Software:

The following companies and organizations are involved in operating system (OS) efforts related to UWB technology. Many third-party companies as well as initiatives have yet to be officially announced.

- IAnywhere—[www.ianywhere.com/](http://www.ianywhere.com/)
- Linux—[linuxuwb.org/](http://linuxuwb.org/)
- Microsoft—[www.microsoft.com/whdc/system/bus/uwb/default.mspx](http://www.microsoft.com/whdc/system/bus/uwb/default.mspx)
- StonestreetOne—[www.stonestreetone.com/](http://www.stonestreetone.com/)

### Components:

This list includes those companies who are developing UWB components such as filters, diplexers, antennas, balun and crystal components. Note that this list is not comprehensive as there are many other vendors working in this area who have not yet made any announcements.

- FDK Corporation—[www.fdk.com/](http://www.fdk.com/)
- Fractus—[www.fractus.com/news\\_details.php?id=52](http://www.fractus.com/news_details.php?id=52)
- Fujitsu Components Ltd.—<http://www.fujitsu.com/us/services/edevices/components/>
- Murata—[www.murata.com/](http://www.murata.com/)

- Omron—[www.omron.com/ecb/products/whfd/](http://www.omron.com/ecb/products/whfd/)
- Skycross—[www.skycross.com/Products/uwb.asp](http://www.skycross.com/Products/uwb.asp)
- Taiyo Yuden—[www.ty-top.com/](http://www.ty-top.com/)
- TDK—[www.component.tdk.com/](http://www.component.tdk.com/)

### Test Equipment & Services:

Test equipment and services for UWB technology include things like regulatory and compliance test, protocol certification, and bench test and automated test equipment.

The following companies are involved in these efforts:

- Agilent—[www.agilent.com/find/UWB](http://www.agilent.com/find/UWB)
- Anritsu—[www.anritsu.com/](http://www.anritsu.com/)
- CETECOM—<http://www.cetecom.es/web/es/pag/24112415.htm>
- Ellisys—[www.ellisys.com/](http://www.ellisys.com/)
- LeCroy—[www.lecroy.com/tm/products/ProtocolAnalyzers/UltraWideband/UWB](http://www.lecroy.com/tm/products/ProtocolAnalyzers/UltraWideband/UWB)
- LTX—<http://www.ltx.com/ltxweb.nsf/published/WirelessRF?Open>
- Tektronix—[www.tek.com/Measurement/applications/rf/uwb.html](http://www.tek.com/Measurement/applications/rf/uwb.html)
- Teradyne—[www.teradyne.com/](http://www.teradyne.com/)

## News Headlines

• **WiMedia Alliance**—In an effort to expand the global presence of the WiMedia Alliance ([www.wimedia.org](http://www.wimedia.org)), WiMedia has opened the China Chapter. WiMedia China engages Chinese regulators and Chinese-based consumer electronic corporations.

• **Belkin and Intel**—Belkin Corporation ([www.belkin.com](http://www.belkin.com)) will implement the Intel ([www.intel.com](http://www.intel.com)) Wireless UWB link 1480 MAC silicon in its upcoming USB adapter based on WiNet and Certified Wireless USB technology. The adapter will be available in the first quarter of 2007.

• **USB-IF**—USB-IF ([www.usb.org](http://www.usb.org)) has announced the availability of the Certified Wireless USB Compliance and Certification program. It is the only way for manufacturers to achieve certification and qualify to use the Certified Wireless USB logo.

• **Staccato Communications**—Staccato Communications ([www.staccatocommunications.com](http://www.staccatocommunications.com)) is prepared to submit six reference designs based on Certified Wireless USB for certification by the USB-IF, U.S. FCC certification, and Japan TELEC regulatory approval. These reference design kits are production-ready for the retrofit market of dongle and hub adapter products.

• **Intel, Eastman Kodak and Alereon**—In collaboration with Intel ([www.intel.com](http://www.intel.com)) and Eastman Kodak ([www.kodak.com](http://www.kodak.com)), Alereon ([www.alereon.com](http://www.alereon.com)) demonstrated wireless transmission of photos from a digital camera to a PC. For the demonstration, photos were taken using a Kodak digital camera embedded with Alereon's AL4000 wireless USB solution. The photos were downloaded to a PC via an Intel wireless USB host dongle solution containing the Intel wireless UWB link 1480 media access controller and Alereon's AL4000 PHY.

• **WiQuest Communications**—WiQuest Communications ([www.WiQuest.com](http://www.WiQuest.com)) has earned FCC certification for its external USB adapter solution. Designed using WiQuest's multichip solution, it includes the SiGe-based RF front-end (WQST101) and CMOS-based baseband PHY, MAC engine, processor, and a variety of host interfaces (WQST110).

• **Agilent Technologies**—Agilent Technologies ([www.agilent.com](http://www.agilent.com)) is shipping key test equipment and software necessary to verify operation of devices based on Certified Wireless USB technology from the USB Implementer's Forum. **EWT**

# Bluetooth Technology: Moving at high speed

By Michael Foley

Moore's Law correctly predicted the pace at which technology would progress: doubling the complexity of integrated circuits every 24 months. In semiconductors this has proven true even if the pace has been slightly adjusted. In progressing a standard like Bluetooth wireless technology—working with more than 6000 member companies from industries as varied as automotive, television and mobile phone—there is no predictable pace for enhancing the technology and a healthy level of debate on what constitutes progress.

Therefore, when the Bluetooth SIG gained consensus to move forward on the creation of a high-speed Bluetooth channel using UWB technology from the WiMedia Alliance, it was after much collaborative effort. Overall, the Bluetooth SIG was able to achieve agreement from its members that 1) they wanted a high-speed version of Bluetooth technology, 2) working with UWB technology would be the fastest and most beneficial pathway to achieve that goal, and 3) the WiMedia MBOA UWB technology was the most advantageous solution for Bluetooth technology's future high-speed channel.

The WiMedia Alliance and its membership agreed to collaborate on a high-speed Bluetooth solution in late March. This announcement came at the Bluetooth SIG All Hands Meeting. Finalizing this agreement is a huge accomplishment for the Bluetooth SIG. More important, it is a proof point of the organization's dedication to identifying synergies and cooperating within the wireless industry to develop the best overall wireless solutions to meet member and consumer expectations.

## Developing the specification

The Bluetooth SIG now moves into the important phase of doing the work to make this vision a reality. With the March WiMedia announcement came the formation of the Bluetooth SIG PHY/MAC subgroup of the core specification working group. It is made up of experts from companies instrumental in Bluetooth wireless technology and UWB specification development such as Motorola, RF Micro Devices, Texas Instruments and CSR, among others. Together, they will work to meet the feature, profile and marketing requirements for a 2007 version of the Bluetooth specification, code named Seattle. The main requirements for the high-speed Bluetooth channel set forth by the core working group will ensure consistency of capability and design, using Bluetooth technology. It will add features including improved pairing and enhanced security (see the figure).

Requirements for the new high-speed specification include the following:

- Use legacy Bluetooth wireless technology for device discovery, service discovery, error recovery and physical layer discovery, as well as re-establish the link if the UWB link is lost at any time.
- Use Bluetooth profiles to transmit data through any available alternative MAC/PHY common to both sides.
- Maintain low cost and low power of Bluetooth wireless technology. Use Bluetooth technology to turn on and off the UWB portion.
- Reuse the Bluetooth stack and profiles that may require minor modifications.
- Create additional profiles or MAC features taking advantage of the increased throughput of the new technology.
- Maintain backward compatibility with previous versions of the specification.

## The foreseeable future

With the announcement of 1 billion Bluetooth enabled products shipped, Bluetooth wireless technology has secured a place in the market. In addition, the move to high-speed has received positive industry acceptance.

According to a study on the potential of a Bluetooth/UWB collaboration, commissioned by the Bluetooth SIG and conducted by the IDC industry analyst firm, "By providing a clear road map, user model guidelines, and Bluetooth/UWB tools, as well as scoping and defining the focus areas for Bluetooth and UWB, the Bluetooth SIG and member companies can help expedite and facilitate the transition, coexistence, and integration between Bluetooth technology and UWB in the market. By focusing on the applications that fit the technologies most appropriately, the Bluetooth SIG can put a stake in the ground, define its territory, and give hardware vendors a technology road map."

No magic formula exists to predict the pace of Bluetooth's future. Despite this, the roadmap in place indicates that the Bluetooth SIG will help ensure the technology's future by continuing to meet and exceed its members' expectations, as well as the needs of consumers. **EWI**

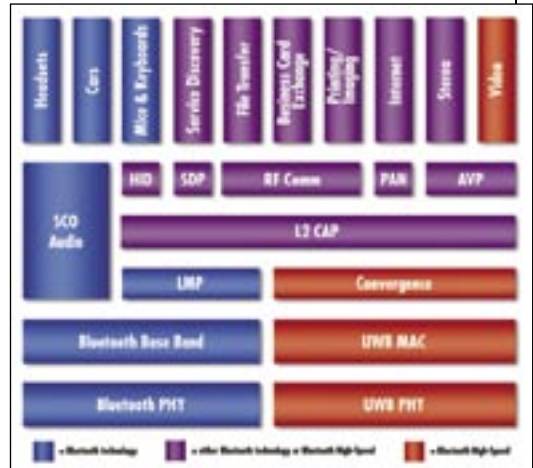

Proposed image of the Bluetooth/UWB stack.

Dr. Michael Foley is the executive director of the Bluetooth Special Interest Group.



# UWB PRODUCT HIGHLIGHTS

**Note:** The UWB resource page should be consulted to find additional companies that offer UWB silicon and software solutions, as well as test and design services.

## Reference design portfolio increases by three

The SC3224R combo Bluetooth mini card reference design kit from Staccato Communications ([www.staccatocommunications.com](http://www.staccatocommunications.com)) combines both

Bluetooth 2.0 EDR technology and Certified Wireless USB onto a single PCI Express mini card form factor design. SC3224R provides a fully integrated wireless PAN solution for notebook PCs. Its design enables the use of a single antenna shared simultaneously by both radios through a diplexer without any significant degradation in performance to either radio. Sharing a single antenna and a single mini card slot, the SC3224R reference design kit eliminates the need for additional antennas or mini card slots to the system.

While the initial version of the SC3224R reference design kit will support current-generation Bluetooth 2.0 EDR and Certified Wireless USB for dual-mode wireless PANs, future generations of the reference design will support tri-mode functionality by adding Bluetooth 3.0 capabilities.

Staccato has also added the SC3225R USB HWA half mini card and SC3226R Wireless USB secure digital I/O (SDIO) card to its portfolio of reference designs. Based on Certified Wireless USB and the WiMedia platform, these complete, production-ready reference designs feature firmware and drivers, and target mobile handset, PDA and PC notebook applications.

SC3225R is half the size of a standard PCI Express mini card, allowing the notebook PC vendor maximum flexibility in form factor design and system integration of multiple wireless technologies. SC3226R is based on Staccato's Ripcord family of single-chip, all-CMOS solutions. Providing a highly integrated solution for embedded applications, it supports native host, native device and/or dual-role-device modes through an SDIO 1.1 device interface.

## Silicon, host reference designs target digital home/office

Silicon and reference designs for UWB host solutions are now available from Intel ([www.intel.com](http://www.intel.com)). The Intel Wireless UWB Link 1480 media access controller (MAC) silicon and reference designs are based on the Certified Wireless universal serial bus (USB) specification from the USB Implementers Forum and the WiMedia Network specification from the WiMedia Alliance. They will allow independent hardware vendors, PC manufacturers and device OEMs to deliver high-bandwidth, low-power wireless solutions that provide personal area network connectivity in the digital home and office.

Intel's UWB host MAC silicon is integrated with multiple third-party UWB physical layers, to offer customers a choice of radio solutions in its host reference designs. The Intel host solution enables concurrent operation of Certified Wireless USB and

WiNet and has been demonstrated to interoperate with multiple device peripherals such as cameras and printers. These UWB host solutions enable PCs, printers and digital TVs with existing high-speed USB ports to be upgraded to support wireless personal connectivity through USB dongles and ExpressCards.

## UWB reference design family expands

Alereon's ([www.alereon.com](http://www.alereon.com)) family of UWB reference designs has been expanded to include Mini PCI and ExpressCard/34 designs for host applications. The existing family of reference designs includes Cardbus and USB dongles for WiMedia and Wireless USB hosts, and compact Flash cards for devices based on Certified Wireless USB.

The Alereon mini PCI and ExpressCard/34 reference designs provide fast and simple ways for customers to generate solutions based on Certified Wireless USB from the USB Implementers Forum or on the WiMedia specification for desktop and laptop PCs. The ExpressCard/34 features superior performance and lower power consumption compared to the aging Cardbus or PCMCIA slot, making it a suitable choice for today's UWB solutions. Mini PCI is a smaller-sized implementation of the common PCI specification already used today in designs for laptop and desktop computers. Both the mini PCI and ExpressCard/34 reference designs are available using multiple WiMedia media access controller (MAC) chip vendors.

## Evaluation kit available for UWB PHY

An evaluation kit for the single-chip CMOS, RTU7010 WiMedia-based UWB physical layer (PHY) is available. Realtek Semiconductor's ([www.realtek.com.tw](http://www.realtek.com.tw)) RTU7010-EVK evaluation kit consists of two RTU7010 daughter boards, two MAC-PHY interface controllers in CardBus form factor, PCI driver, easy-to-use GUI, user manual and data sheets, plus required power supplies. It enables detailed evaluation of RTU7010 performance, compliance, and interoperability, including transmitter quality, power measurement, spectrum measurement, receiver sensitivity, packet error rate, separate diagnostics for header and frame check sequences, and link quality indicator for all data rates and channels. Additionally, it allows testing in either single or dual receive antenna mode, making evaluation of the performance advantages of maximum ratio combining (MRC) possible.

## Dual-band RF CMOS transceiver core being readied for delivery

Infineon Technologies ([www.infineon.com](http://www.infineon.com)) has successfully taped-out of a dual-band UWB RF transceiver core based on the company's CMOS process. The core supports both the 3 GHz to 5 GHz frequency band and the above -6 GHz band up to 9 GHz, as defined by WiMedia. Ideally suited for both Certified Wireless USB and Bluetooth-over-WiMedia UWB systems, it will be an essential component for UWB system manufacturers developing applications like wireless video streaming, picture download and file transfer at speeds up to 480 Mbps. In addition to applications in mobile devices, the UWB RF-CMOS transceiver technology is also suitable for PCs, printers, DVD drives, TV sets, and other consumer electronic devices. A single-chip CMOS UWB device, including MAC, PHY and RF transceiver, based on WiMedia UWB specifications is planned for release in mid-2007. **EWI**

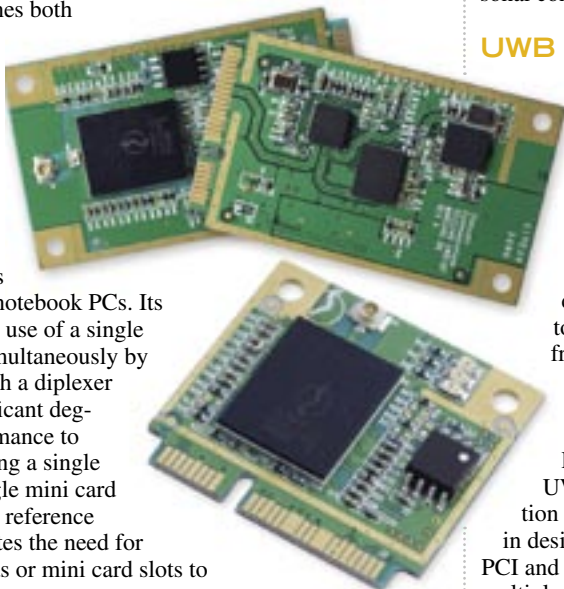

# Ad index

November 2006

Bluetooth SIG .....	S7
Ellisys .....	S20-S21
KC Wirefree .....	S10
Linx Technologies .....	S13
LucidPort Technology, Inc. ....	S11
M/A Com .....	SIBC
NDK America .....	S3
Omniyig Inc. ....	S23
RF Micro Devices .....	S2
Rohde & Schwarz .....	SBC
Staccato Communications .....	S5
USB Implementers Forum .....	S9

## Our staff

**Editor:** Cheryl Ajluni  
cherylajluni@yahoo.com

**Managing Editor:** Dawn Hightower  
dhightower@prismb2b.com

**Art Director:** Susan Lakin  
slakin@prismb2b.com

**Art Director:** Doug Coonrod  
dcoonrod@prismb2b.com

**Ad Production Coordinator:** Beth Manley  
bmanley@prismb2b.com  
913-967-1831

**Associate Publisher:** Judy Miller  
jmiller2@prismb2b.com  
212-204-4246

## Contact your Sales Representative to advertise!

### Northern California and West Sales:

**Twyla Sulesky**

408-393-4777 • tsulesky@prismb2b.com

### Southern California Sales:

**Shelley Kelly**

310-547-1777 • shkelly@prismb2b.com

### Associate Publisher:

**Judy Miller**

212-204-4246 • jmiller2@prismb2b.com

### Eastern/Midwestern U.S. Sales:

**Tracy Smith**

913-967-1324 • tsmith@prismb2b.com

### European Sales:

**Victoria Hufmann**

49 (0) 911 939764-42 • victoria@hufmann.in

### Classified, Marketplace & Catalog Sales:

**Julie Dahlstrom**

312-840-8436 • jdahlstrom@prismb2b.com

*Continued from page 28*

done using antennas. The Wireless USB specification defines how Wireless USB devices and hosts must operate. It also defines specific classes of devices to help enable market development. These are the host wire adapter (HWA) and the device wire adapter (DWA). The HWA is a UWB radio that is attached to a PC through a wired USB connection. The DWA is similar to a wired USB hub, except that its connection to the PC is through Wireless USB. Wireless USB testing covers device testing, HWA testing, DWA testing, and physical layer testing. All Wireless USB devices must pass the WiMedia platform tests and use a WiMedia registered PHY.

Device testing includes analyzing all of the device-based information (descriptors) that devices have, as well as the appropriate behavior and response to the various Wireless USB commands, including basic enumera-

tion, security and association. This testing is done using a stand-alone program that runs on the host PC.

HWA and DWA testing covers the details of required HWA and DWA behavior. It includes testing of the 'wired' side of each device. Testing is done using the host PC as well as test devices that allow appropriate exercise of the devices under test.

Physical layer testing does a subset of the WiMedia PHY testing. This testing is done to ensure the product integrator properly designed in the WiMedia Registered PHY and chose an antenna that will deliver a good user experience. To do the compliance tests, a directional high-gain antenna is connected to a digital sampling scope. The Wireless USB loopback test mode is used to make the DUT transmit packets across a mix of channels, rates and packet sizes. The ability of the DUT to transmit and receive at reduced power levels is checked. The DUT is also positioned

with various orientations to the host radio, including in the vertical plane.

Products that pass Wireless USB compliance and certification testing and have signed a logo license with the USB-IF, may display the certified Wireless USB logo on literature and packaging. Specifics of the tests can be found at [www.usb.org/developers/wusb/](http://www.usb.org/developers/wusb/).

## Conclusion

WiMedia and the USB-IF have developed a comprehensive set of certification tests that will help ensure end-product interoperability and coexistence, as well as end-user satisfaction. There has been unprecedented cooperation between member companies to make sure that the first wave of products truly do peacefully coexist and interoperate. **EWI**

## ABOUT THE AUTHOR

Brad Hosler is the chairman of USB-IF and WiMedia certification.

# M/A-COM MMIC power to the extreme

## High Power, Broadband Amplifiers

Part Number	Frequency	Output Power
MAAPGM0074-DIE	2.0 – 8.0 GHz	8 W
MAAPGM0076-DIE	1.3 – 2.5 GHz	16 W
MAAPGM0077-DIE	0.7 – 2.5 GHz	13 W
MAAPGM0078-DIE	2.0 – 6.0 GHz	12 W
MAAPGM0079-DIE*	9.5 GHz	20 W

\*Contact us for additional performance data.



M/A-COM high power,  
high performance  
GaAs MMICs

## Let M/A-COM maximize your power and performance

M/A-COM MSAG™ technology provides the industry's best functionality and performance with the most mechanically robust MMICs available on the market today. These MMICs are produced on a mature and reliable process line that is highly repeatable for minimizing chip variation. M/A-COM has customized solutions for defense and commercial applications including point-to-point radios, SatCom, military and commercial radar, test instrumentation and avionics.

For complete information visit [www.macom.com](http://www.macom.com) or contact our sales office.

North America 800.366.2266 • Europe +44 (0) 1908.574200  
• Asia/Pacific +81.44.844.8296 • [www.macom.com](http://www.macom.com)

M/A-COM and Tyco are trademarks.

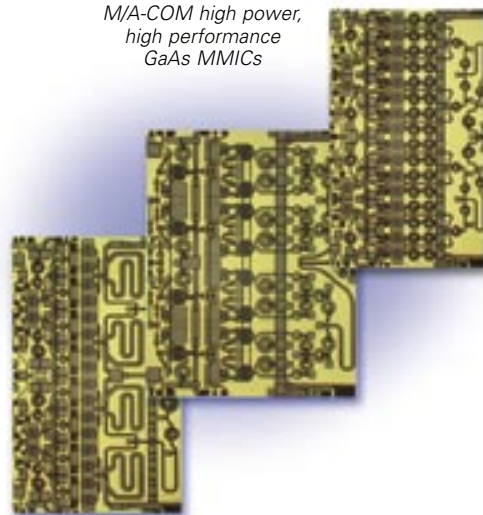

MSAG technology  
(Multifunction Self-Aligned  
Gate MESFET)  
for highly integrated  
MMICs

*a vital part of your world*

**tyco**  
Electronics



## WiMAX hotspot.

### Test & measurement solutions from the last mile to the last inch.

WiMAX is ushering in a new era of fast wireless data access in places that never had it before.

Rohde & Schwarz has the test & measurement solutions you need to be ready:

- Higher speed
- Superior spectral performance
- Superior adjacent channel performance
- The only signal generators with on-board WiMAX personality

We can help ensure that your WiMAX solution is performing to spec – wherever the last mile may take you. Find out more at [test-rsa.com/WIMAX/RFD](http://test-rsa.com/WIMAX/RFD), and while you're there, get your free 488-page Test & Measurement catalog.



**ROHDE & SCHWARZ**

[rohde-schwarz.com/USA](http://rohde-schwarz.com/USA) • 1-888-837-8772